

MCIB

Marine Casualty Investigation Board
Bord Imscrúdú Taisní Muirí



**REPORT OF AN INVESTIGATION
INTO THE FIRE AND LOSS
OF THE YACHT BLACK MAGIC
OFF THE
SOUTH COAST OF CORK
13 DECEMBER 2021**

**REPORT NO. MCIB/313
(No.2 OF 2023)**

The Marine Casualty Investigation Board (MCIB) examines and investigates all types of marine casualties to, or onboard, Irish registered vessels worldwide and other vessels in Irish territorial waters and inland waterways.

The MCIB objective in investigating a marine casualty is to determine its circumstances and its causes with a view to making recommendations to the Minister of Transport - for the avoidance of similar marine casualties in the future, thereby improving the safety of life at sea and inland waterways.

The MCIB is a non-prosecutorial body. We do not enforce laws or carry out prosecutions. It is not the purpose of an investigation carried out by the MCIB to apportion blame or fault.

The legislative framework for the operation of the MCIB, the reporting and investigating of marine casualties and the powers of MCIB investigators is set out in the Merchant Shipping (Investigation of Marine Casualties) Act, 2000.

In carrying out its functions the MCIB complies with the provisions of the International Maritime Organisation's Casualty Investigation Code and EU Directive 2009/18/EC governing the investigation of accidents in the maritime transport sector.



Leeson Lane, Dublin 2.
Telephone: 01-678 3485/86.
email: info@mcib.ie
www.mcib.ie

The Marine Casualty Investigation Board was established on the 25th March 2003 under the Merchant Shipping (Investigation of Marine Casualties) Act, 2000.

The copyright in the enclosed report remains with the Marine Casualty Investigation Board by virtue of section 35(5) of the Merchant Shipping (Investigation of Marine Casualties) Act, 2000. No person may produce, reproduce or transmit in any form or by any means this report or any part thereof without the express permission of the Marine Casualty Investigation Board. This report may be freely used for educational purposes.

**REPORT OF AN INVESTIGATION
INTO THE FIRE AND LOSS
OF THE YACHT BLACK MAGIC
OFF THE
SOUTH COAST OF CORK
13 DECEMBER 2021**

**REPORT NO. MCIB/313
(No.2 OF 2023)**

Glossary of Abbreviations and Acronyms

CGR	Coast Guard Radio
CoP	Code of Practice*
DSC	Digital Select Calling
ETA	Estimated Time of Arrival
FV	Fishing Vessel
GPS	Global Positioning System
GRP	Glass Reinforced Plastic
IRC	International Rating Certificate
IRCG	Irish Coast Guard
ISA	Irish Sailing Association
LOA	Length Overall
MN	Marine Notice
MOP	Member of the Public
MRCC	Marine Rescue Co-ordination Centre
MRSC	Marine Rescue Sub-Centre
PFD	Personal Flotation Device
RIB	Rigid Inflatable Boat
RNLI	Royal National Lifeboat Institution
SAR	Search and Rescue
SITREP	Situation Report
UTC	Co-ordinated Universal Time
VHF	Very High Frequency

Centimetres	cm
Cubic centimetres	cc
Feet	ft
Horsepower	hp
Kilograms	kg
Kilometres	km
Kilowatts	kW
Knots	kt
Litres	(lts)
Metres	m
Nautical miles	NM
Tonne	t

*Updates to the Code of Practice: The Safe Operation of Recreational Craft (2017), (Marine Notice No.51 refers), were published in November 2019. The updates can be downloaded in electronic format at: <https://www.gov.ie/en/publication/66ff7e-safe-operation-of-recreational-craft/>

	PAGE
1. Summary	4
2. Factual Information	5
3. Narrative	14
4. Analysis	17
5. Conclusions	22
6. Safety Recommendations	23
7. Appendices	24
8. MSA 2000 Section 36 - Correspondence Received	56

Report MCIB/313 published by the Marine Casualty Investigation Board.
23rd March 2023.

1. SUMMARY

- 1.1 The yacht Black Magic with one person onboard sailed from the Yacht Marina, Crosshaven, Co Cork for Kinsale Harbour at approximately 10.30 hrs on 13 December 2021. Approximately one hour and a quarter later at 11.50 hrs the outboard engine mounted on the transom of the yacht, caught fire. The fire rapidly spread. The Skipper transmitted a MAYDAY distress broadcast using his handheld Very High Frequency (VHF) radio. A fishing vessel (FV) working in the vicinity of the burning yacht relayed a MAYDAY to the Irish Coast Guard (IRCG) radio station at Valentia who initiated a Search and Rescue (SAR) operation.
- 1.2 Another fishing vessel rescued the Skipper at approximately 12.00 hrs and brought him to safety. Shortly after, at 12.17 hrs the Skipper was transferred ashore by the Port of Cork Rigid Inflatable Boat (RIB) which had come from Crosshaven to assist. The Skipper was not injured during the incident. The yacht was consumed by fire. At 12.48 hrs Crosshaven Royal National Lifeboat Institution (RNLI) reported that the yacht had sunk in Ringabella Bay.

Note: Times are local time = UTC + 1 (Co-ordinated Universal Time + 1).

See Appendix 7.1 - Photograph No. 1 Yacht Black Magic.

See Appendix 7.2 - Photograph No. 2 Burning Yacht Black Magic off Ringabella Bay.

2. FACTUAL INFORMATION

2.1 Vessel Details

Name:	Black Magic.
Type:	Monohull yacht, cruiser/racer.
Manufacturer:	Beneteau, France.
Date of Construction:	1996 (owner's report).
Model type:	First Class 8 (FC8).
Description:	<p>Yacht Black Magic was a FC8 racing yacht. The FC8 type yacht was designed in 1982. The FC8 is a long keelboat compared with its class competitors with straight lines enabling a dinghy style planning hull with a considerable wetted surface area which makes it slow in light airs.</p> <p>These yachts are one of Europe's most competitive sailing class racing yachts with more than 1,000 units sold between 1982 and 1994.</p>
Registration:	Irish Sailing Association (ISA) and Racing Class Association.
Sail Number:	GBR2088R.
Length Overall:	7.75 metres (m) (25.42 feet (ft)).
Waterline length:	7.75 m (21.67 ft).
Beam:	2.49 m (8.2 ft).
Weight:	1.4 tonne (t).
Construction:	Glass Reinforced Plastic (GRP), aluminium alloy spars, stainless steel wire standing rigging.
Auxiliary engine:	PARSUN 3 horsepower (hp) single cylinder 4-stroke outboard, mounted on a transom bracket. Manufactured by PARSUN.

2.2 Yacht Black Magic had International Rating Certificate (IRC) and ECHO certificates for racing and was purchased in June 2021 by the Owner (who was also the Skipper) for racing purposes. The yacht had raced from October to December

2021 in Cork Harbour and at the time of the incident was being brought to Kinsale Boatyard for winter lay-up.

2.3 Vessel Equipment

Before sailing from Crosshaven the vessel was de-stored of non-essential equipment in preparation for its winter lay-up (storage and maintenance ashore). Equipment (including safety equipment) remaining onboard for the trip to Kinsale on 13 December 2021 was as follows:

- Mainsail.
- Halyards and Sheets for mainsail.
- Mainsail Boom and Spinnaker pole.
- Winch handles.
- Fixed bilge pump x 1 and hand-held bilge pump x 1.
- Boat hook.
- Fire extinguisher (inside yacht cabin).
- Lifebuoy.
- Flares (Coastal flares (pyrotechnics)).
- Global Positioning System (GPS) (handheld).
- Paper navigation chart in sail bag.
- Compass.
- Navigation lights (ColRegs compliant).
- VHF radio (handheld).
- Personal Flotation Device (PFD) (Buoyancy Aid).
- Anchor chain and warp.
- Outboard engine (Petrol 4-stroke, PARSUN).
- Spare spark plug and plug spanner.
- Spare fuel: Five litre (lts) drum plus approximately 2.5 lts in second drum (i.e., two drums containing a total of 7.5 lts petrol fuel).

Equipment onboard yacht Black Magic did not include a suitable fixed Marine Band VHF radio transmitter, with Digital Select Calling (DSC) facility as recommended in the publication: Code of Practice (CoP): The Safe Operation of Recreational Craft 2017, for category C - inshore boats.

2.4 Outboard Engine

The outboard engine fitted to yacht Black Magic was purchased by the Owner in June 2021 as part of the yacht sale. The Owner stated the engine was not serviced at the time of the sale and had not been serviced in the interim before the incident. He recounted that the engine was to be serviced during the yacht's winter lay-up. He described the outboard engine as being a PARSUN 4-stroke petrol engine of approximately 3 hp capacity. The outboard engine was connected to the yacht on an outboard engine bracket fitted off the centreline on the starboard side of the open transom immediately adjacent to the rudder. The outboard engine had an integral fuel tank on top of the engine housing with a filler cap/vent on its upper surface.

PARSUN outboard engines are manufactured by Suzhou Parsun Power Machine Co. Ltd in Suzhou, China (www.parsunpower.en.made-in-china.com). The website advertises a range of 4-stroke outboard petrol engines ranging from 20 hp to 2.6 hp.

- 2.4.1 The Skipper's description and photograph indicate the outboard engine may be either a PARSUN F4 (4 hp) or the PARSUN F2.6 (2.6 hp) series engine. Both engines feature tiller control, pull start and integral fuel tanks with fuel filling and air vent caps. Specifications for the PARSUN F2.6 are very similar to the PARSUN F4.0 as follows:

	PARSUN F4	PARSUN F2.6
Dry weight:	24.5 kilograms (kg)	18 kg
Displacement:	112 cubic centimetres (cc)	72 cc
Max fuel consumption:	1.6 lts/hr	1.1 lts/hr
Fuel tank capacity:	1.3 lts	1.2 lts
Sump oil capacity:	0.5 lts	0.35 lts
Transom height:	381/508 centimetres (cm)	381/508 cm

The PARSUN F2.6 model is more closely aligned with the Skipper's description of the engine as being approximately 3 hp. Details of the internal arrangements including fuel system lines and fuel filling arrangements are also similar.

See Appendix 7.3 - Photograph No. 3 - Outboard Engine Fitted to Yacht Black Magic.

See Appendix 7.4 - Photograph No. 4 Location of the Outboard Engine Fitted to Yacht Black Magic.

See Appendix 7.5 - Information on the PARSUN F2.6 4-Stroke Petrol Engine - Pages 1-8.

See Appendix 7.6 - PARSUN F2.6 Engine Fuel Arrangement.

2.4.2 The relationship between engine power and waterline length of a racing yacht is referenced in the “The Boat Data Book”, fifth edition 2003, by Ian Nicolson and published by Adlard Coles Nautical. “The Boat Data Book” is a contemporary reference book for anyone concerned with boats and ships and provides a means for checking the standard of equipment for a variety of boats including racing yachts and sailing boats. Yacht Black Magic was a FC8 racing yacht and was a 25.42 ft long keelboat with a dinghy style planning hull.

2.4.2.1 The reference book “The Boat Data Book” contains a section at page 132 referring to outboard engines for small sailing boats, day boats and centreboard dinghies. The section contains a graph of minimum horsepower against waterline length to achieve a speed of six miles per hour (5.2 knots (kts)). The graph is for guidance only but gives a rough indication of the size of engine using waterline length as a basis.

Page 132 of “The Boat Data Book” states “*The following conditions apply:*”

- 1 *The waterline length is the basis.*
- 2 *A 50% overload is allowed for.*
- 3 *With headwinds or steep seas the speed will drop. In very severe conditions double the horse power shown may be scarcely adequate to maintain way.*
- 4 *This graph is a guide only. Easily driven hulls and those lightly laden may need less power. Heavy boats with deeply immersed transoms and a lot of windage are likely to need more power”.*

The graph is based on the Manual of the BIA, Chicago, to whom acknowledgement is made.

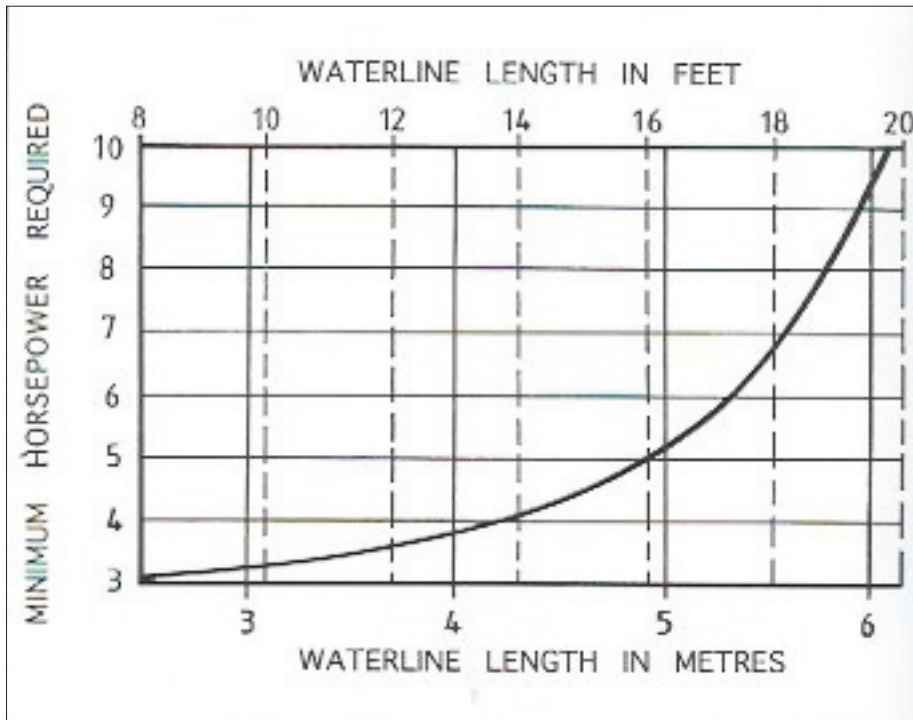

Page 132 The Boat Data Book

It can be seen from the graph that the maximum measurement on the waterline axis is 20 ft, and 10 hp is the recommended minimum horsepower required to achieve six miles per hour (5.2 kts). At 8 ft waterline length the minimum horsepower required to achieve 5.2 kts is 3 hp.

Yacht Black Magic overall length was 25.42 ft, and its waterline length was 21.67 ft.

By extrapolating the curve, it is estimated that for a craft of approximately 22 ft waterline length (such as yacht Black Magic), the minimum horsepower required to achieve 5.2 kts is in excess of 10 hp.

2.4.2.2 The Design section of “The Boat Data Book” at pages 162 and 163 respectively refers to the relationship between engine power and waterline length in the context of inboard engines onboard yachts between 20 to 45 ft waterline length and depicted in the graph on page 163 of the book and shown below.

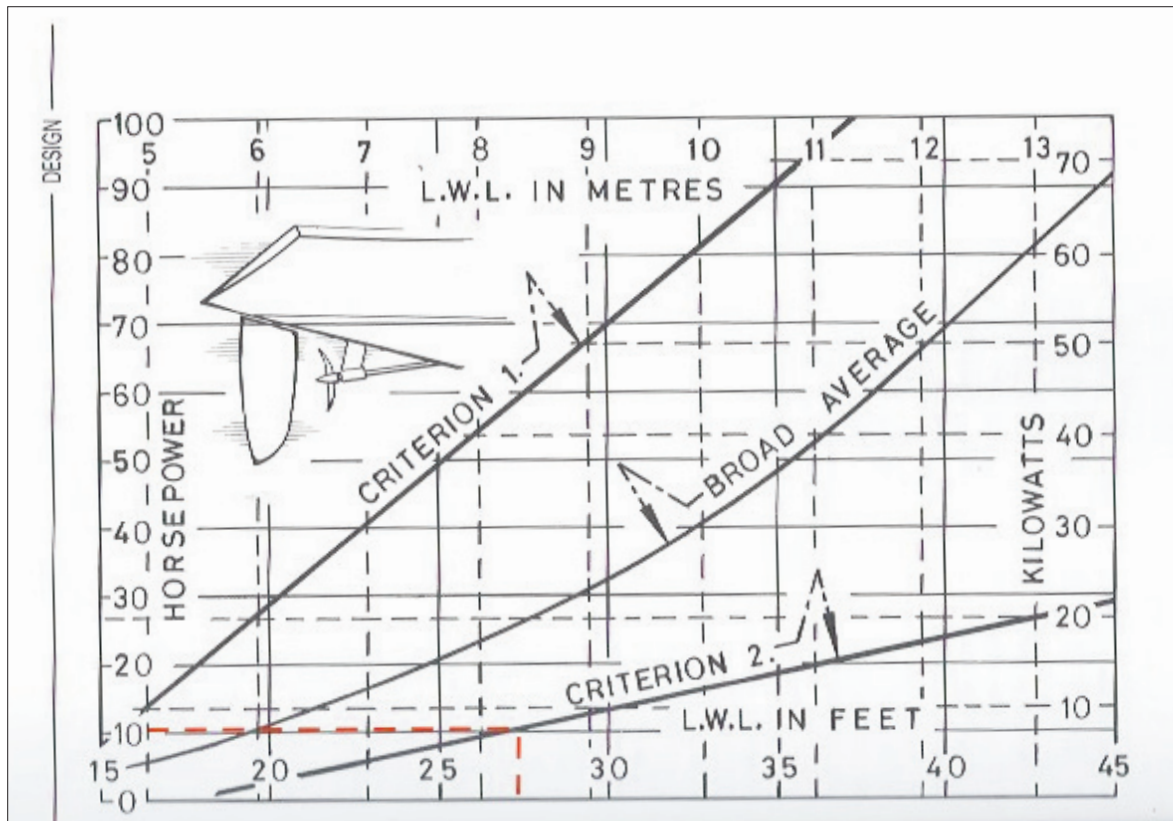

© Ian Nicolson, 2003, The Boat Data Book, Adlard Coles Nautical, an imprint of Bloomsbury Publishing Plc.

Page 163 Boat Data Book

The book states “The bottom curve, labelled CRITERION 2 shows the size of engine sometimes fitted in racing craft, and on sailing yachts with good light weather performance. It (the engine) should give power to charge the batteries and get the yacht home in windless conditions. It is economical but may not be powerful enough to deal with adverse tides. In quite small waves, progress may be halted.”

This graph indicates that a yacht with a waterline length of approximately 22 ft would require a 5-6 hp inboard engine to charge the batteries and get the yacht home in windless conditions.

See Appendix 7.7 The Boat Data Book pages 132, 162 and 163.

2.5 Crew Details

Yacht Black Magic had one crew onboard (the Skipper) for the delivery trip to the Kinsale Boatyard on 13 December 2021. The Skipper’s marine experience and competencies are as follows:

- A boat owner and a qualified yachtsman since 1994. The Skipper is an Irish national.

- Yachtmaster Offshore, Certificate of Competency No. 577 since 12 August 1994 and renewed every five years thereafter. Last renewed 23 July 2021 and therefore valid to 23 July 2026.
- Holder of a Radio Operators Licence No. 9174.
- Sea Survival course completed in 1994.

2.6 Voyage particulars

Yacht Black Magic departed Crosshaven in Cork Harbour at approximately 10.30 hrs on the morning of Monday 13 December 2021 with one crewmember onboard (the Skipper), for a delivery voyage to a Kinsale Boatyard for winter lay-up and maintenance.

See Appendix 7.8 Chart - Planned Route from Crosshaven to Kinsale Harbour.

See Appendix 7.9 Chart - Position of Sinking of Yacht Black Magic.

The yacht was expected by boatyard staff and scheduled to be lifted out of the water at 15.00 hrs on 13 December 2021 prior to its winter lay-up. The distance to Kinsale Boatyard from Crosshaven is 19.1 nautical miles (NM) which required an average speed over the ground of 4.2 kts to reach the destination on time.

The Skipper recalled he expected to make an average speed of 4 to 4.5 kts over the ground GPS by hugging the coast to avoid the remaining tide. The Skipper expected the tide to be in his favour for approximately three quarters of the voyage to Kinsale Harbour.

2.7 Type of Casualty

This was a marine incident involving a fire onboard a yacht which posed the potential threat of death or serious injury and resulted in the loss of the vessel. This incident involved the rescue services. This type of casualty is as defined in Part 1, Section 2 of the Merchant Shipping (Investigation of Marine Casualties) Act, 2000.

2.8 Emergency Response and Timeline

13 December 2021. Emergency Response as per Irish Coast Guard (IRCG Marine Rescue Sub Centre (MRSC) Valentia - Situation Report (SITREP) UIIN2883/21.

Note: All times are stated in Co-ordinated Universal Time (UTC). i.e. ZULU (Z) time.

11:52 Z Member of the Public (MOP) reported a yacht on fire at the

entrance to Cork Harbour.

- 11:53 Z IRCG tasked the Crosshaven RNLI lifeboat and at 11:54 hrs, Rescue Helicopter R117 (Waterford based).
- 11:54 Z FV Boy Connor broadcast 'MAYDAY' relay from the Skipper onboard the burning yacht.
- 11:56 Z RNLI LB launched and proceeding to incident scene.
- 11:58 Z FV Mawrena (FV Muir Einne in media reports), reported that one person (the Skipper/Casualty), had been taken from the burning yacht. This was confirmed by FV Annabella at 12:01 hrs.
- 12:06 Z The Casualty was transferred to the Port of Cork RIB Delta 1 for transfer to the Royal Cork Yacht Club club house in Crosshaven for medical assessment.
- 12:17 Z The Casualty was landed ashore at the RNLI station and assessed by the RNLI's station medical doctor. The Casualty was collected by a relative and brought home.
- 12:48 Z The burning yacht reported as sunk in position 51° 46.35'N 008° 16.8'W (Ringabella Bay). There was no debris or pollution.
- 13:00 Z Crosshaven RNLI Lifeboat stood down and returned to base. Incident closed

See Appendix 7.10 IRCG SITREP

2.9 Environmental Conditions

2.9.1 Weather conditions according to IRCG SITREP UIIN2883/21

Wind: Beaufort Force 1, Easterly.

Sea: Moderate.

Swell: Low Wave.

Air temperature: 8.1 degrees Celsius (°C).

Water temperature: 10°C.

2.9.2 Weather conditions according to Met Éireann 'Estimated weather conditions for Cork Harbour/Roches Point area on the morning of Monday 13 December 2021 between 09.00 hrs and 13.00 hrs UTC.'

Wind: Winds light to moderate Beaufort Force 3 or 4 (mean wind speed 6-10 kts) with occasional gusts up to 16 kts. Wind direction was east

north easterly.

Sea: The estimated sea state conditions in the offshore area south of Roches Point was moderate to rough.

Swell: Significant total wave height of 2.5 m to 3.0 m and maximum wave height 4.5 m. Swell direction was south westerly.

Air temperature: 6°C or 7°C.

Water temperature: 11°C.

2.9.3 The tide was on the flood into Cork Harbour from approximately 07.00 hrs and at the time of the yacht's departure from Crosshaven. The tide was due to turn and ebb from Cork Harbour at approximately 13.00 hrs (High Water Roberts Cove 13.05 hrs local time). The tidal flows would be against any vessel departing Cork Harbour before approximately 13.00 hrs but would change and become favourable after approximately 13.00 hrs for vessels on a south westerly course along the coast heading for the mouth of Kinsale Harbour.

Tide Times: Robert Cove 13 December 2021 (tidetimes.co.uk).

High Tide: 00.28 hrs.

Low Tide: 07.14 hrs.

High Tide: 13.05 hrs.

Low Tide: 19.44 hrs.

2.9.4 Sunrise/Sunset: Sunrise 08.32 hrs.

Sunset 16.23 hrs.

See Appendix 7.11 Met Éireann Weather Report.

See Appendix 7.12 Tide and Light Conditions 13 December 2021 (Information courtesy of www.tidetimes.co.uk).

3. NARRATIVE

- 3.1 Yacht Black Magic was purchased by the Skipper in June 2021, six months prior to the incident. The Skipper's intention was to race the yacht. The yacht competed in Cork Harbour's 2021 Autumn Leagues (October to December). After the League was over the Skipper intended to lay-up the vessel in a boatyard in Kinsale Harbour to carry out winter maintenance and equipment services. Winter lay-up entailed moving the yacht from its berth in Crosshaven to Kinsale Harbour in time for the yacht to be lifted out of the water in the Kinsale Boatyard. This lay-up event was previously arranged, and the Skipper recounted that he was expected by the boatyard staff to arrive about 15.00 hrs for the yacht's annual lift-out. The Skipper recounted that he used the boatyard for annual winter lay-ups with his previously owned boats since 1993.
- 3.2 Whilst planning the trip from Crosshaven to Kinsale Boatyard the Skipper consulted the weather forecast for 13 December 2021, voyage distance and tidal information and decided conditions were favourable to make the trip. The Skipper had 30 years' sailing experience and was very familiar with the 19 NM route from Cork Harbour to Kinsale Harbour. He estimated the delivery trip would take approximately four to five hours depending on wind conditions. He planned for a minimum of four hours motor sailing using the yacht's mainsail and outboard engine, expecting to make 4 to 4.5 kts speed towards Kinsale. High water in Roberts Cove was at 13.05 hrs and would ebb from that time onwards until low water at 19.44 hrs. Therefore, tidal flows would be against the yacht's progress as it made its way out of Cork Harbour entrance. From approximately 13.00 hrs tidal flows reverse and become favourable for the passage, with an ebb tide flowing out of Cork Harbour and westwards along the coast in the direction of Kinsale Harbour. The Skipper's planned refuge safe havens were Roberts Cove or Oysterhaven.
- See Appendix 7.8 Chart - Planned Route from Crosshaven to Kinsale Harbour.
- See Appendix 7.11 Met Éireann Weather Report.
- 3.3 Before he left the marina in Crosshaven the Skipper filled the fuel tank of the outboard engine with petrol. The Skipper hoisted the yacht's mainsail whilst alongside the marina as the winds were unexpectedly light. He started the outboard engine and Yacht Black Magic motor sailed from Crosshaven and out through Cork Harbour entrance.
- 3.4 Sea conditions were flat calm with light airs from the east. Once past the entrance the Skipper recounted that the wind remained light from an easterly direction. The engine was providing the yacht's propulsion. The sea was calm and there was a sea swell from the southwest. As the yacht came abreast of Ringabella Bay he recalled he topped up the engine fuel tank. Approximately ten to 15 minutes later he was settling down for lunch when there was a "*flame out*

of the engine and a bang". A fire started at the engine and immediately spread to the spare drums of petrol fuel adjacent to the open transom stern of the yacht's cockpit. The Skipper evacuated the cockpit onto the deck to escape the flames which had spread to the transom and cockpit area. He did not enter the cabin as he was afraid the petrol fuel tanks would explode and trap him inside. The fire spread quickly, as the GRP materials of the yacht's structure began to burn with a considerable amount of dense black smoke and flames. The engine had stopped, and forward motion had ceased. The light easterly wind caused the yacht to point up to the wind blowing the dense black smoke away from the bows area. The Skipper had made his way forward and was now standing at the bow on the foredeck. This position allowed him to keep clear of the flames from the burning hull and black smoke which blew downwind and astern of the yacht.

See Appendix 7.2 Photograph No. 2 Burning Yacht Black Magic off Ringabella Bay.

- 3.5 The Skipper broadcast a distress MAYDAY using his handheld VHF radio which he had hanging on its lanyard around his neck. Despite broadcasting on 'full power', he recounted that there was no reply from the Coast Guard Radio (CGR) (the Skipper assumed the hills around Ringabella Bay blocked the line-of-sight VHF distress broadcast from the CGR relay mast). However, two fishing vessels (the FV Boy Connor and FV Muir Einne) working within the vicinity of the entrance to Cork Harbour, heard the Skipper's distress MAYDAY broadcast. FV Boy Connor relayed the MAYDAY and this broadcast was picked up by Valentia CGR at 11.54 hrs.

See Appendix 7.10 IRCG SITREP.

The Skipper recalled that he was listening to the VHF radio transmissions and learned that the emergency services were responding. He recalled the fire travelled very fast along the yacht and was close to the mast area by this time. He was contemplating jumping into the sea to escape the flames and smoke but resolved to delay entering the sea for as long as possible.

- 3.6 A smaller fishing boat, the FV Annabella, with two crew onboard, was nearby tending to shrimp pots. The crew spotted the burning yacht and immediately made haste towards the vessel. The fishermen were unable to see the yacht's Skipper as the smoke was dense. For this same reason the Skipper did not see the fishing vessel until it was approximately 20 m distance from his position at the bows of the burning yacht. The crew of the FV Annabella spotted the Skipper standing at the bows of the burning yacht and immediately came alongside the bows allowing the Skipper to jump aboard and escape the flames.

See Appendix 7.2 Photograph No. 2 Burning Yacht Black Magic off Ringabella Bay.

The FV Annabella withdrew and brought the Skipper to safety. Approximately five minutes later the flames had enveloped the mast deck area. The halyards and mainsail were on fire and the mainsail collapsed to the deck. The Skipper recounted he heard several loud bangs which he presumed were the petrol tanks exploding.

- 3.7 In the meantime, the Harbour Master in Crosshaven heard the VHF broadcasts and CG SAR response and was making his way onboard the Port of Cork RIB Delta 1 around to the incident scene, arriving shortly after the Skipper had been rescued by the crew of FV Annabella. The Skipper was transferred to the RIB Delta 1 and brought quickly to Crosshaven's RNLI station where he was checked out by the RNLI doctor and found in good health. The Skipper was then collected by a relative and brought home. Yacht Black Magic burned down to its waterline and sank at 12.48 hrs in Ringabella Bay. The RNLI lifeboat reported there was no pollution or debris from the yacht remaining afloat.

See Appendix 7.10 IRCG SITREP.

4. ANALYSIS

- 4.1 The fire onboard yacht Black Magic was central to this incident. The yacht was on passage to Kinsale Boatyard under power when a fire broke out and quickly consumed the yacht which eventually sank off Ringabella Bay. There are several factors that must be considered to understand how the fire originated, ignited and eventually caused the loss of the yacht.
- 4.2 Weather and sea conditions. Yacht Black Magic was a FC8 racing yacht. The FC8 is a 25.42 ft long keelboat weighing 1.4 t with a dinghy style planning hull. This design is characterised as having a considerable wetted surface area which makes it slow in light airs (see paragraph 2.1).
- 4.2.1 The yacht left Crosshaven at approximately 10.30 hrs and was due to arrive at Kinsale Boatyard for 15.00 hrs for a scheduled lift-out. The distance to Kinsale Boatyard from Crosshaven is 19.1 NM which required an average speed of 4.2 kts over the ground to reach the destination on time.
- 4.2.2 The sea state was moderate to rough with a south westerly swell, but winds were light from east north easterly. The Skipper expected to make the voyage while motor sailing, but the light winds experienced at the outset of the voyage provided little motive power. Also, the sea swell and tide were acting against the yacht's progress as it headed south through Cork Harbour's entrance en route to Kinsale Harbour. At the initial stage of the voyage the light winds were from astern of the yacht but provided little benefit for the yacht's speed. The Skipper had expected, at the outset of the voyage, to make the necessary speed by a combination of sail and engine power. However, only the yacht's outboard engine provided the power to attain the necessary average speed (4.2 kts over the ground) required to deliver the yacht to Kinsale by the arranged time. The lack of wind to assist the yacht's passage to Kinsale on time was a contributory factor to the loss of the yacht.
- 4.3 The outboard engine. The Skipper described the outboard engine as a PARSUN 4-stroke petrol engine of approximately 3 hp capacity.
- This engine unit was likely to be a PARSUN F2.6 but also may have been the F4 model which is very similar in construction and design but with 1.2 hp more power capacity.
- 4.3.1 The relationship between engine power and waterline length of a racing yacht is described at paragraph 2.4.2 using the "Boat Data Book", fifth edition, by Ian Nicholson as reference. Yacht Black Magic was a 25.42 ft long (waterline length 21.67 ft) keelboat with a dinghy style planning hull using an outboard engine (approximate 3 hp) for auxiliary propulsion.

4.3.2 The engine power standard recommended by the reference book “The Boat Data Book” for a yacht with approximately 22 ft waterline length is depicted graphically in both graphs contained in paragraphs 2.4.2.1 and 2.4.2.2. The graph shown in paragraph 2.4.2.1 indicates that a yacht such as yacht Black Magic with a waterline length of approximately 22 ft would require an outboard engine significantly more than 10 hp to achieve 5.2 kts. The graph shown in paragraph 2.4.2.2 indicates the power required from an inboard engine for the same size of yacht would be in the region of 6-7 hp. The Skipper required an average speed of 4.2 kts over the ground to reach the destination on time. Therefore, it is estimated that a yacht such as yacht Black Magic would require an outboard engine with a power capacity in the region of at least 8 hp to achieve 4.2 kts.

4.3.3 It may be reasonably deduced the PARSUN F2.6 (or F4, if fitted) outboard engine was at maximum throttle power to achieve the speed of 4.2 kts required to make the appointed time of arrival at Kinsale Boatyard. Any combustion engine continuously working at maximum power or beyond its design criteria output will develop significantly high temperatures at exhaust ports and moving parts in the crank-spaces. It is reasonable to deduce that this engine, while achieving the speed necessary to deliver the yacht to its appointed destination on time, was operating at the upper limits of its mechanical and power operating envelope.

The sub-optimal capacity of the outboard engine was a contributory factor to the loss of yacht Black Magic.

4.4 Refuelling the engine at sea. The Skipper recounted that before he left the marina in Crosshaven he filled the fuel tank of the PARSUN outboard engine with petrol and started the engine. The PARSUN engine provided the motive power for the yacht from the start of the voyage.

At its maximum power output, a PARSUN F2.6, (2.6 hp) fuel consumption is specified as 1.1 lts/hr. Similarly, the PARSUN F4 (4 hp) engines fuel consumption is 1.6 lts/hr maximum power output.

4.4.1 The Skipper topped up the fuel tank of the engine ten to 15 minutes before the incident which occurred at approximately 11.50 hrs, that is at around 11.35 hrs, in the vicinity of Ringabella Bay. It may be deduced from the figures for fuel consumption that the outboard engine was operating at maximum throttle power output to reach this point of replenishing the fuel and furthermore it is reasonable to deduce the fuel tank required more than a litre of petrol to top it up.

4.4.2 The sea state was moderate to rough with significant total wave heights between 2.5 m to 3.0 m and a south westerly swell. Decanting fuel into the

outboard engine's fuel tank positioned on top of the engine while experiencing sea swells of 2.5 m to 3.0 m heights would be challenging and some fuel spillage onto the engine tops and/or around the vicinity of the transom area was more than likely.

See Appendix 7.3 Photograph No. 3 Outboard Engine Fitted to Yacht Black Magic.

See Appendix 7.4 Photograph No. 4 Location of the Engine Fitted to Yacht Black Magic.

See Appendix 7.6 PARSUN F2.6 Engine Fuel Arrangement.

- 4.4.3 The design of the PARSUN F4 and F2.6 engines incorporates a heat shield barrier plate which separates the fuel tank filling arrangement from the engine's hot surfaces when the engine hood is properly fitted and secured. This barrier plate is positioned to seal any fuel spillage at the fuel tank filling point from leaking down onto the hot engine surfaces of the engine's crank/cylinder head.

See Appendix 7.5 Information on the PARSUN F2.6 4-Stroke Petrol Engine - Pages 1-8.

See Appendix 7.6 PARSUN F2.6 Engine Fuel Arrangement.

- 4.4.4 The Skipper recounted that the fire started when there was a "*flame out of the engine and a bang*" approximately 15 minutes after topping up the engine's fuel tank located on top of the engine. It is surmised that if the fuel had spilled directly onto the engine hood top it would be prevented from leaking into the engine by a correctly fitted and serviceable heat shield barrier plate and immediate ignition of the petrol fuel vapours would be avoided. The Skipper recounted that the fire started approximately 15 minutes after he topped up the fuel tank. This time span is inconsistent with the likelihood of fuel vapours directly igniting as a result of spillage from the refuelling operation. However, the presence of spilled fuel in and around the engine and transom area was very likely. Spilled fuel from the refuelling operation was very likely a contributory factor in the fire and loss of yacht Black Magic.

- 4.5 Operation of the outboard engine. The outboard petrol engine fitted to yacht Black Magic was part of the yacht sale when purchased by the Owner/Skipper in June 2021, six months prior to the incident. The engine was not serviced at the time of the sale and had not been serviced prior to the incident. The age of the engine was not determined during this investigation and the condition of the engine at the time of the incident is not known. The engine is presently in the sea with the remains of the yacht off Ringabella Bay and its condition cannot be assessed.

- 4.5.1 The Skipper recounted that the fire started when there was a “*flame out of the engine and a bang*” approximately 15 minutes after topping up the engine’s fuel tank located on top of the engine. This description indicates that some mechanical failure occurred within the engine body and ignited either fuel or lubricating oil and/or ignited the vapours from spilled fuel ignited in or on the engine.
- 4.5.2 The likelihood of mechanical failure of an engine increases if the engine is overdue a service. The likelihood of mechanical failure is further increased if the engine is run continuously at or beyond its design criteria. Given that the engine was operated at or above its maximum operating criteria, and the unknown service history and condition of this engine, the likelihood of it suffering a significant mechanical failure was likely. It is surmised that the continuous operation of the engine at its maximum design capacity was a causative factor in the fire and subsequent loss of the yacht.
- 4.6 Ignition of the fire. It has been deduced that the outboard engine was operating at or above its design capacity and it was surmised the engine required service maintenance. One of the risks resulting from operating an engine above its design capacity is the risk of mechanical failure.
- 4.6.1 Such failures may manifest in a variety of ways. A compromised or blown cylinder head gaskets allowing very hot exhaust gasses to escape into the engine hood compartment or a piston or piston ring failure allowing hot exhaust gases into the oil vapour laded crankcase. The above scenarios are typical mechanical failures associated with operating engines above the design criteria.
- 4.6.2 It has already been deduced that it was likely the engine suffered a mechanical failure. The flashpoint of oil is the minimum temperature at which the oil gives off flammable vapour which, on the application of a flame, will cause momentary ignition. A typical flashpoint for lubricating oil is approximately 230°C (closed flash point test). The fire point of an oil is the temperature at which the volatile vapours given off from a heated sample of the oil is ignitable by flame application and will burn continuously. The fire point temperature can be anything up to approximately 40°C higher than the closed ‘flashpoint’ temperature for oils. Gasoline or petrol has a very low flashpoint of -23°C. This means that petrol is explosive at normal ambient temperatures and under almost all conditions there is an explosive atmosphere directly above petrol. The engine features flexible fuel hoses connecting the fuel tank to the carburettor adjacent to and inside the engine hood. It is surmised the fuel and lubricating oil temperatures in the PARSUN outboard engine exceeded their flash and ignition points. It is surmised that the outboard engine suffered a mechanical failure resulting in exposed engine parts in the proximity to fuel system parts or oil vapours causing petrol fuel or oil lubricant vapours to ignite. The ignition of a fire in the outboard engine was a causative factor in the fire and loss of the yacht Black Magic.

- 4.7 Emergency communications. The Skipper broadcast a distress MAYDAY using his handheld VHF radio. Despite broadcasting on full power he recounted that there was no reply from the CGR. Fishing vessels working within the vicinity heard the Skipper's distress MAYDAY broadcast. FV Boy Connor relayed the MAYDAY and this broadcast was picked up by Valentia CGR at 11.54 hrs and a SAR operation commenced from that time onwards.
- 4.7.1 The Skipper could not communicate with the emergency services directly because the transmission power of the hand-held radio was insufficient. Yacht Black Magic was not fitted with a suitable fixed Marine Band VHF radio transmitter, with DSC facility which would have better transmission power.
- 4.7.2 Flares were carried onboard but stored inside the cabin. When the fire occurred, the Skipper avoided entering the cabin for fear of being trapped and therefore was unable to access the flares to send up a distress flare. If it were not for the presence of small fishing boats within the incident's immediate vicinity and within the range of the Skipper's hand-held VHF radio, then the incident may have had a worse outcome. The absence of a fixed marine band VHF radio or the isolation of the flares from ready use by the Skipper were not factors in the outcome of this incident.

5. CONCLUSIONS

- 5.1 The continuous operation of the outboard engine onboard yacht Black Magic as it made passage from Crosshaven marina to the vicinity off Ringabella Bay at the engine's maximum design capacity, caused the engine to suffer a significant mechanical failure. The mechanical failure of the engine was such that hot engine components were exposed to petrol fuel and oil lubricants which spontaneously ignited and caused a fire onboard the vessel. The fire consumed the vessel which subsequently sank off Ringabella Bay.
- 5.2 The lack of wind and the sub optimal capacity of the yacht's outboard engine to power the yacht at the required speed as it motor sailed out of Cork Harbour was a contributory factor in the loss of yacht Black Magic.
- 5.3 Refuelling the outboard engine by topping up the engine's fuel tank likely resulted in a fuel spillage in the vicinity of the engine and transom. The spilled fuel was likely to have been a contributory factor in the subsequent fire which started at the outboard engine and resulted in the loss of the yacht.

6. SAFETY RECOMMENDATIONS

- 6.1 The Minister for Transport should amend or update the Code of Practice: The Safe Operation of Recreational Craft advising owners and operators to ensure auxiliary engines fitted to racing yachts adequately provide the necessary power to allow safe inshore or coastal passage particularly when adverse weather or sea conditions prevail.
- 6.2 The Minister for Transport should publish a Marine Notice highlighting the risks associated with refuelling operations or decanting volatile flammable liquids, at sea or alongside, to or from open containers in the vicinity of hot and exposed surfaces.

7. APPENDICES	PAGE
7.1 Photograph No. 1 - Yacht Black Magic	25
7.2 Photograph No. 2 - Burning Yacht Black Magic off Ringabella Bay	26
7.3 Photograph No. 3 - Outboard Engine Fitted to Yacht Black Magic	27
7.4 Photograph No. 4 - Location of Outboard Engine on Yacht Black Magic	28
7.5 Information on the PARSUM F2.6 4-Stroke Petrol Engine - Pages 1-8	29
7.6 PARSUN F2.6 Engine Fuel Arrangement	37
7.7 The Boat Data Book pages 132, 162 and 163	38
7.8 Chart - Planned Route from Crosshaven to Kinsale Harbour	42
7.9 Chart - Position of Sinking of Yacht Black Magic	43
7.10 IRCG SITREP	44
7.11 Met Éireann Weather Report	45
7.12 Tide and Light Conditions 13 December 2021 (Information courtesy of www.tidetimes.co.uk)	55

Appendix 7.1 Photograph No. 1 Yacht Black Magic



Appendix 7.2 Photograph No. 2 - Burning Yacht Black Magic off Ringabella Bay



Appendix 7.3 Photograph No. 3 - Outboard Engine Fitted to Yacht Black Magic



APPENDIX 7.4

Appendix 7.4 Photograph No. 4 - Location of Outboard Engine on Yacht Black Magic



Appendix 7.5 Information on the PARSUN F2.6 4-Stroke Petrol Engine - Pages 1-8



Appendix 7.5 Information on the PARSUN F2.6 4-Stroke Petrol Engine - Pages 1-8



Description

Features of the PARSUN F2.6 outboard engine

Parsun F2.6ABMS 2.6HP Outboard Motor, 15 Short Shaft, 37.5Lbs / 17kgs, 2 Years back to base Warranty.

Parsun F2.6BML 2.6HP Outboard Motor, 20 Long Shaft, 40Lbs / 18kg

Features

Tiller Handle & Pull Starter; Short Shaft, 1.2L (0.32 US Gallon)
 integral fuel tank; Light weight only 37.5Lbs; 1 cylinder OHV engine
 with 72cc displacement; Full throttle 5250-5750rpm, Max output 2.6HP;
 Compression Ratio 9:1; Gear shift: Forward & Neutral; Gear rate
 2.25; Trim & tilt 4 positions with shallow drive; Aluminum prop
 included.

Easy operation with throttle, choke, recoil starter
 & stop switch; 360 degree steering without gear shifting. Low fuel
 consumption max 1.1L per hour, Quiet & Power technology; Vibration reduction system & Ultra low

Appendix 7.5 Information on the PARSUN F2.6 4-Stroke Petrol Engine - Pages 1-8

consumption max 1.1L per hour, Quiet & Power technology; Vibration reduction system & Ultra low emission with EPA approved. Innovative CDI ignition system for easy starting; Thermostat controlled water cooling system for consistent engine temperature.

It's the smallest portable 4-stroke outboard of Parsun family, this F2.6 definitely holds its own when it comes to getting the job done right every time. One pull to start is most feedback to this little motor, featuring carrying handles for easy transport and store. Efficient and reliable, this little wonder never ceases to amaze.

Parsun outboard motors had been PDI (Pre Delivery Inspection) before packed into the box and ship. Motor oil had been drained out for shipping. This motor use regular 4 stroke motor oil SAE 10W-30, 0.35L. Please add 0.35L motor oil & fill up with the gasoline before start the motor. Please keep the manual and packing for service.

Descriptions

Engine type: 4-stroke, 1-cylinder, OHV
 Displacement: 72 cc (4.4ci)
 Bore x Stroke: 2.13Ä—1.24 inches (54.0Ä—31.5mm)
 Max output: 2.6HP (1.9kW)
 Full throttle RPM range: 5250–5750
 Compression Ratio: 9:1
 Ignition system: TCI
 Starting system: Manual
 Steering system: Tiller control
 Gear shift: Forward - Neutral
 Gear ratio: 2.25 (27/12)
 Trim and tilt system: Manual, 4 positions/Shallow drive
 Max fuel consumption: 1.1 Liter per hour
 Fuel tank capacity: 1.2L
 Sump oil capacity: 0.35L
 Gear oil capacity: 75cc
 Dry weight: 38Lbs (17kg)
 Overall width: 13.5 inches (343mm)
 Recommended boat transom height: 15 -16 inches
 Propeller size: Aluminum / 3 - 7.25 x 6"
 Recommended Fuel: Regular Unleaded (Minimum Pump Octane 87)
 Recommended Oil: 10W-30 or 20W-40

Appendix 7.5 Information on the PARSUN F2.6 4-Stroke Petrol Engine - Pages 1-8

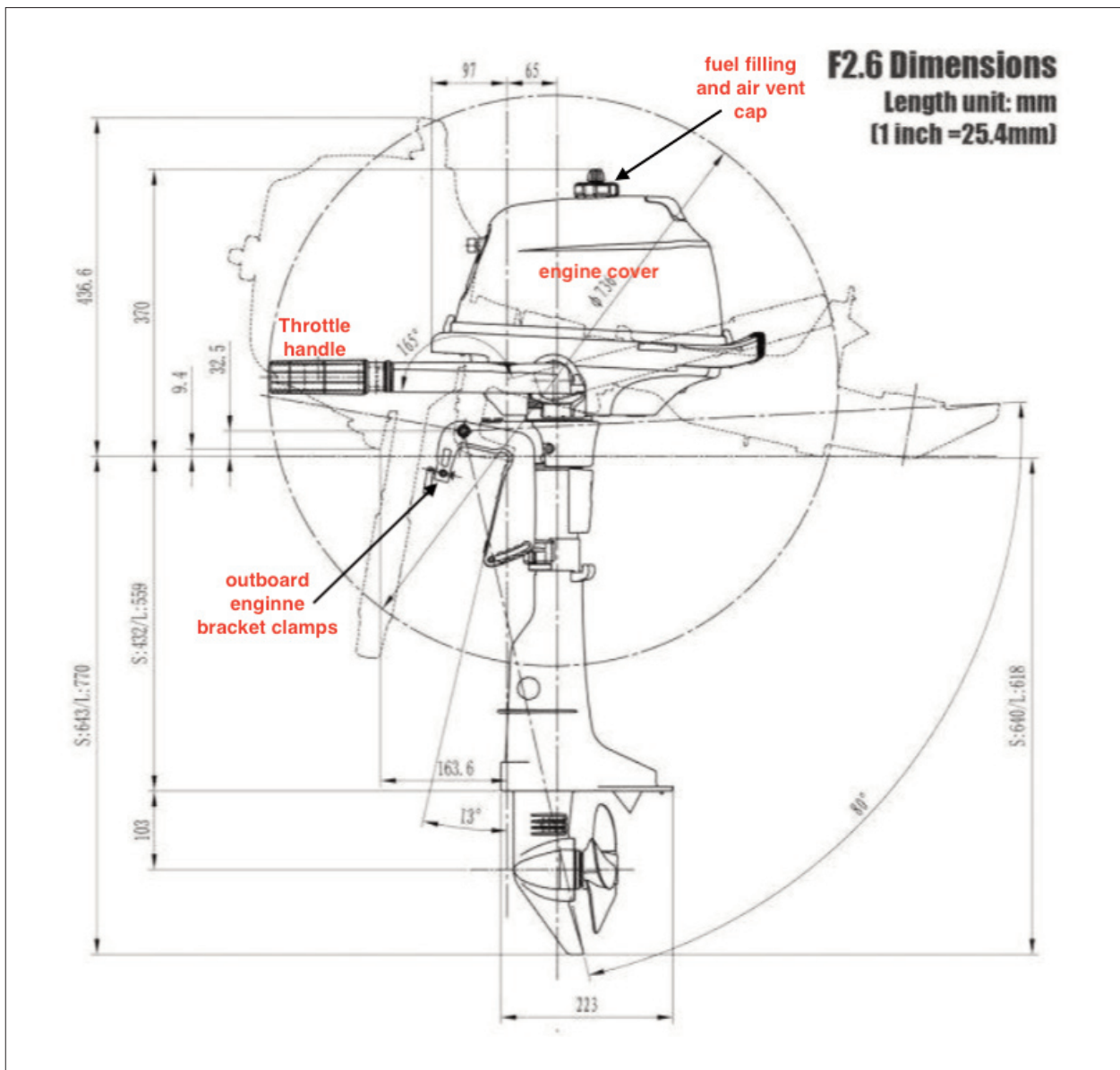

Appendix 7.5 Information on the PARSUN F2.6 4-Stroke Petrol Engine - Pages 1-8

OUTBOARD ENGINE SPECIFICATIONS

Item		Description	Item		Description	
Dimension	Overall length	645mm	Power Unit	Spark plug	BPR7HS	
	Overall width	343mm		Exhaust system	Under water	
	Overall height	1013mm		Lubrication system	Splash lubrication	
Weight		18.0kg	Fuel and Oil	Fuel type	Unleaded regular gasoline	
Performance	Max output	1.9Kw(2.6hp)@5500r/min		Fuel standard	PON86、RON91	
	Full throttle operation	5250~5750r/min		Fuel tank capacity	1.2L	
	Max fuel consumption	1.1L/h@5500r/min		Recommended engine oil	API SE、SF、SE-SF、SG-CD SAE 10W30、10W40	
	Idle speed (Neutral)	1900±100 r/min		Engine oil quantity	0.35L	
Power Unit	Type	4 stroke, OHV		Recommended gear oil	Hypoid gear oil SAE # 90	
	Number of cylinders	1		Gear oil quantity	75mm ³	
	Displacement	72cm ³		Bracket	Tilt angle	0°, 4°, 8°, 12°
	Bore×Stroke	54.0mm×31.5mm			Tilt-up angle	80°
	Compression ratio	9.0			Steering angle	360°
	Number of carburetors	1	Gear positions		F-N	
	Control system	Tiller control	Drive Unit	Gear ratio	2.08 (27/13)	
	Starting system	Recoil starter		Gear type	Bevel gear	
	Ignition control system	T.C.I		Propeller direction	Clockwise	
	Starting enrichment	Chock valve		Propeller drive system	Spline	

Appendix 7.5 Information on the PARSUN F2.6 4-Stroke Petrol Engine - Pages 1-8

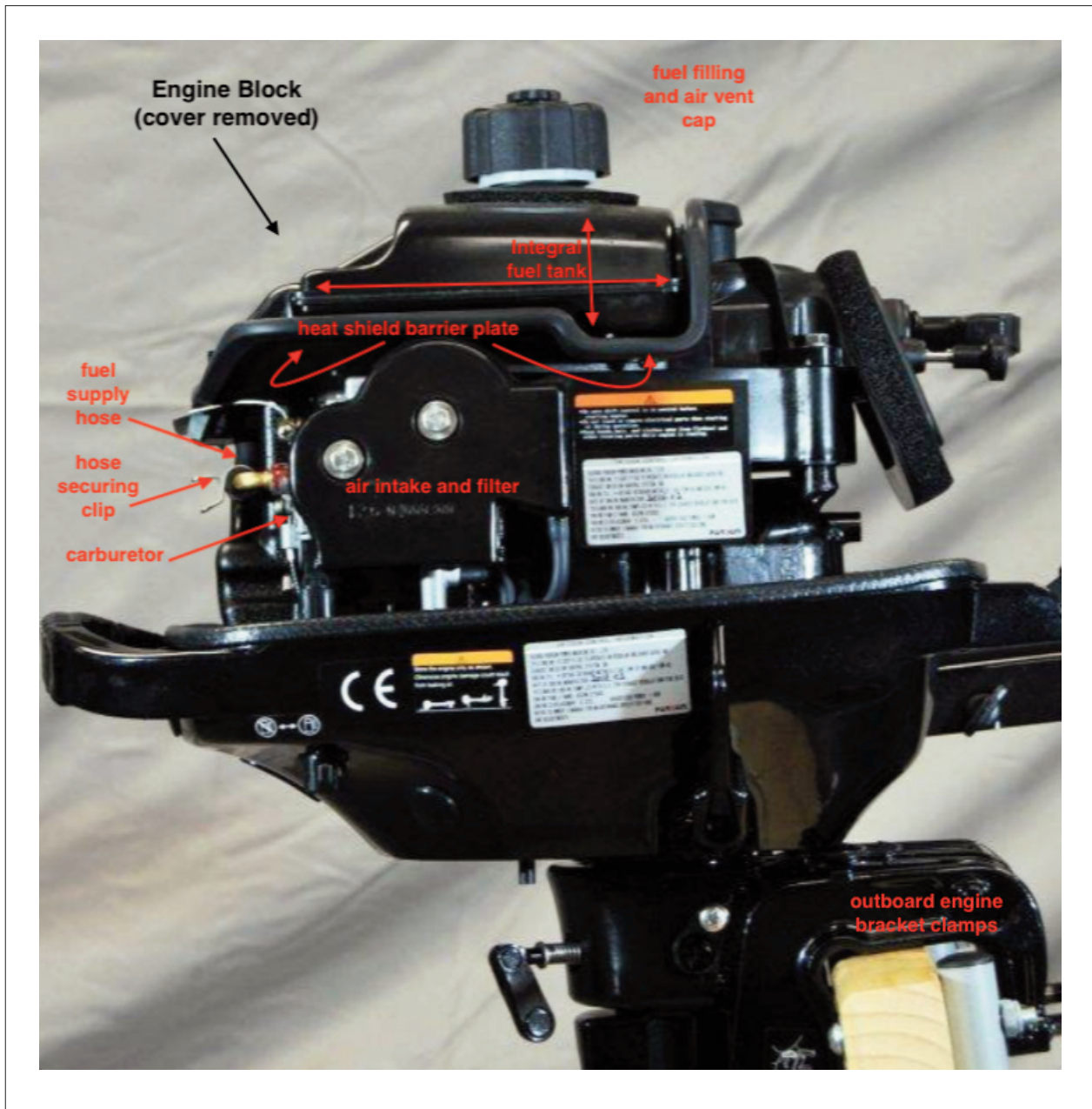

Appendix 7.5 Information on the PARSUN F2.6 4-Stroke Petrol Engine - Pages 1-8

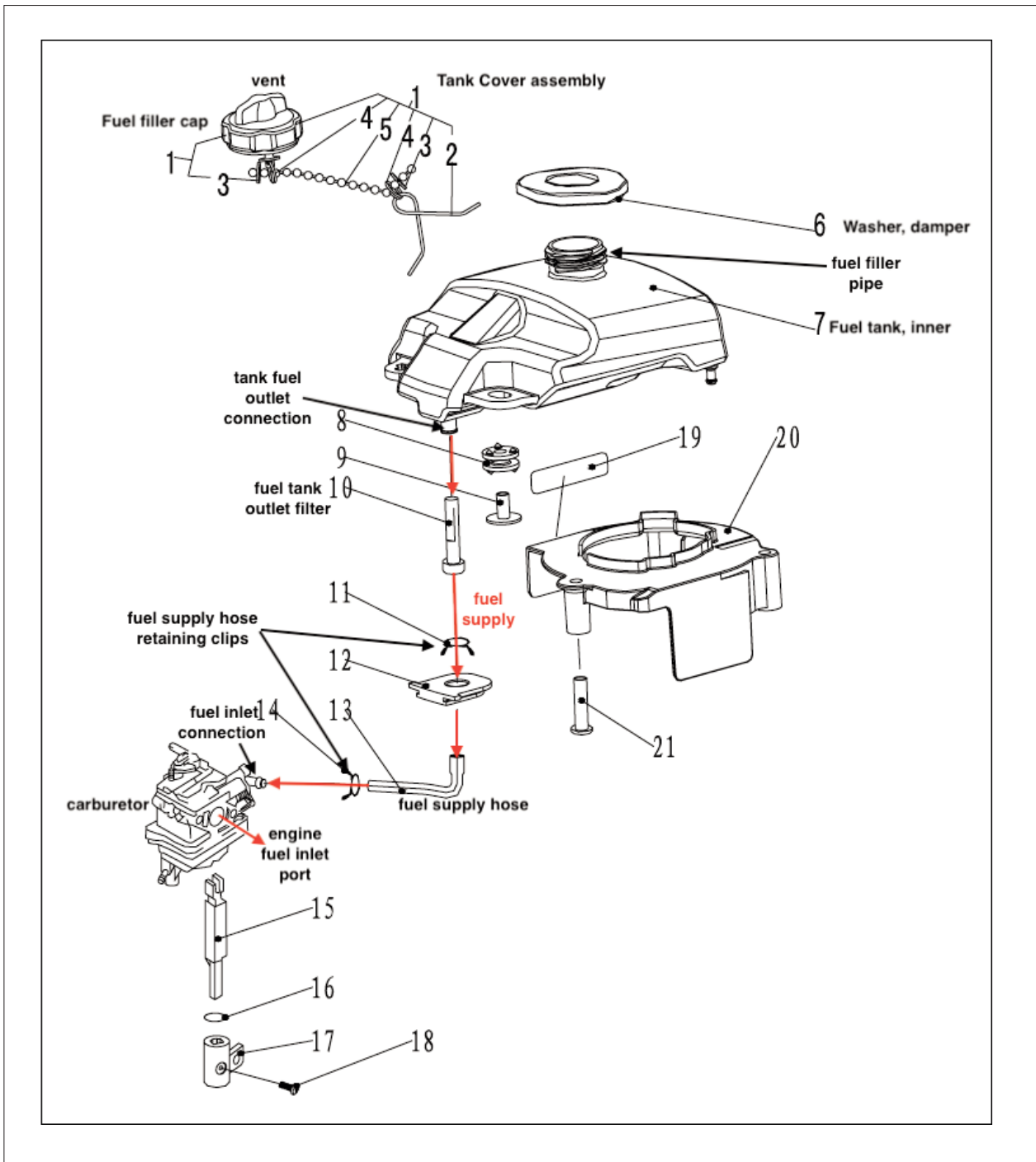

Appendix 7.5 Information on the PARSUN F2.6 4-Stroke Petrol Engine - Pages 1-8

参照号码 SN.	零件编号 PART NO.	零件名称 DESCRIPTION	数量 QTY	备注 REMARKS
1	F4-04120100	油箱盖组件 TANK COVER ASSY	1	
2	F4-04120103	防脱落扭簧 SPRING ,PREVENT DESQUAMATING	1	
3	F4-04120105	防脱落卡片 SHEET METAL ,PREVENT DESQUAMATING	2	
4	F4-04120106	钢丝锁圈 EYELET ,STEEL WIRE	2	
5	F4-04120104	防脱链 CHAIN ,PREVENT DESQUAMATING	1	
6	F2.6-04000033	油箱口减震圈 WASHER ,DAMPER	1	
7	F2.6-04000026	油箱 FUEL TANK ,INNER	1	
8	F2.6-04000027	油箱减震圈A DAMPER ,FUEL TANK	2	
9	F2.6-04000028	油箱减震圈垫管 TUBE ,DAMPER	2	
10	F4-04120005	油箱滤油芯 FILTER ,FUEL TANK	1	

参照号码 SN.	零件编号 PART NO.	零件名称 DESCRIPTION	数量 QTY	备注 REMARKS
11	F4-05000010	油管夹簧A SPRING ,OIL TUBE	1	
12	F4-04000032	油管减震块 DAMPER ,OIL TUBE	1	
13	F2.6-04000029	燃油管 OIL TUBE	1	
14	F2.6-04000030	油管夹簧C SPRING ,OIL TUBE	1	
15	F2.6-04000017	油开关连接杆 CONNECTING-ROD,OIL SWITCH	1	
16	JASOF404 24-014	油开关密封圈Φ13.8x2.4 O-RING	1	
17	F2.6-00000004	油开关旋钮 KNOB ,OIL SWITCH	1	
18	GB/T823-2000	十字槽小盘头螺钉M5x8 SCREW ,PAN HEAD	1	
19	F2.6-04000022	飞轮导风罩 VENTILATIVE COVER	1	
20	F2.6-04000023	导风罩垫管 TUBE ,WASHER	3	

Appendix 7.6 PARSUN F2.6 Engine Fuel Arrangement



Appendix 7.7 The Boat Data Book pages 132, 162 and 163

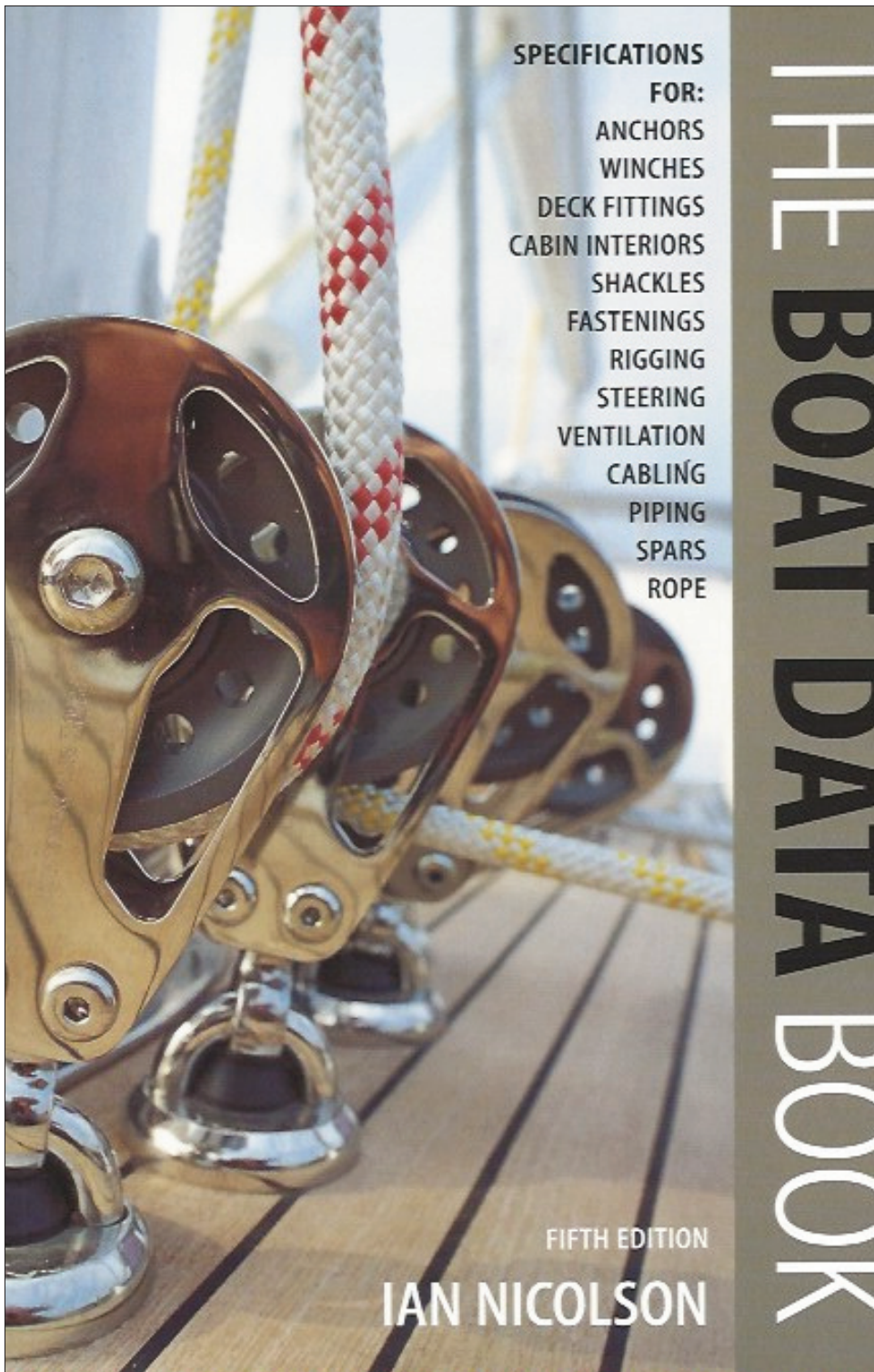

© Ian Nicolson, 2003, The Boat Data Book, Adlard Coles Nautical, an imprint of Bloomsbury Publishing Plc.

Appendix 7.7 The Boat Data Book pages 132, 162 and 163

BOAT DATA BOOK

Outboard engines (3) – for 10 kph (6mph)

This graph is for small sailing boats, day boats and centreboard dinghies.

The following conditions apply:

- 1 The waterline length is the basis.
- 2 A 50% overload has been allowed for.
- 3 With headwinds or steep seas the speed will drop. In very severe conditions double the horse power shown may be scarcely adequate to maintain way.
- 4 This graph is a guide only. Easily driven hulls and those lightly laden may need less power. Heavy boats with deeply immersed transoms and a lot of windage are likely to need more power.

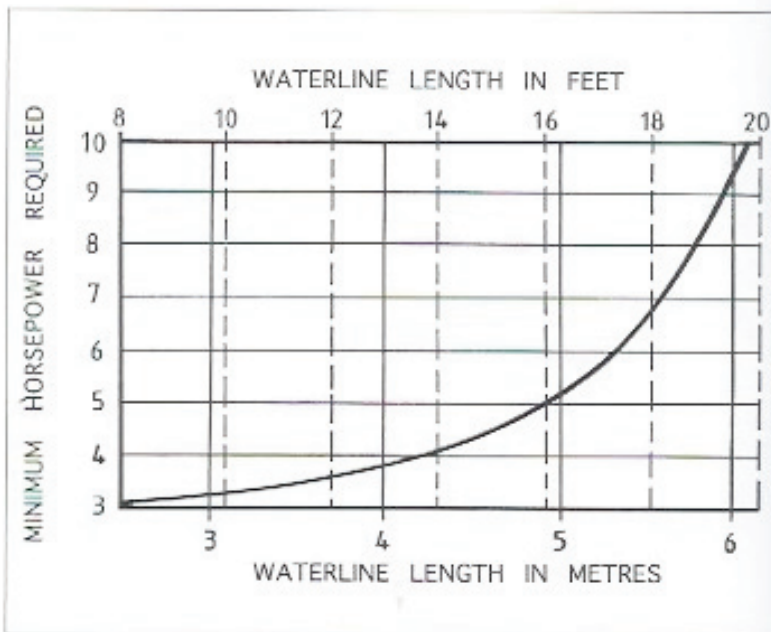

The graph is based on the Manual of the BIA, Chicago, to whom acknowledgement is made.

Appendix 7.7 The Boat Data Book pages 132, 162 and 163

BOAT DATA BOOK

Engine power-v-waterline length

The left side and bottom of the graph opposite are in Imperial measurements of horsepower and feet, shown by continuous lines. The top and right side are in metric measurements of metres and kilowatts, shown with dotted lines. Where two engines are fitted, the horsepower/kilowatt figures are for the total output of both.

The middle curve, labelled BROAD AVERAGE, is the mean of a large number of yachts, with plenty coming above and below this line. A vessel with an engine which comes on this line should have enough power to make progress to windward in rough but perhaps not very severe conditions.

This middle line assumes that the hull form is fair and gives a good flow of water to a well-immersed propeller of average size and good design. It is based on craft with a clean bottom, average windage, and no serious adverse factors such as poor engine line-up.

This BROAD AVERAGE line takes into account the rise in engine power which has occurred year by year. However the engine power put in small craft of all types continues to increase.

The upper curve, marked CRITERION 1 shows the engine size found in powerful motor-sailers and yachts intended for cruising with no thought to racing. Such craft often have more than one alternator on the engine, hydraulic and water pump power-take-offs, and so on. The main engine is expected to deal with large electrical loads, such as those imposed by radar, freezers and winches.

A yacht with an engine on the upper curve should be able to make adequate progress to windward in severe conditions offshore, provided the hull and other components are reliable. She should be able to turn into winds of force 9 (and perhaps more), provided the stern gear and other features are satisfactory, including adequate stability to give the engine a chance to work properly.

A yacht with an engine of the power shown by the upper line will need big fuel tanks, and to work adequately offshore in all conditions may need a feathering propeller. She will certainly need a large propeller, and if this cannot be folded or feathered she will not sail well in all conditions due to propeller drag.

The bottom curve, labelled CRITERION 2 shows the size of engine sometimes fitted on racing craft, and on sailing yachts with good light weather performance. It should give power to charge the batteries and get the yacht home in windless conditions. It is economical but may not be powerful enough to deal with adverse tides. In quite small waves, progress may be halted.

162

Appendix 7.7 The Boat Data Book pages 132, 162 and 163

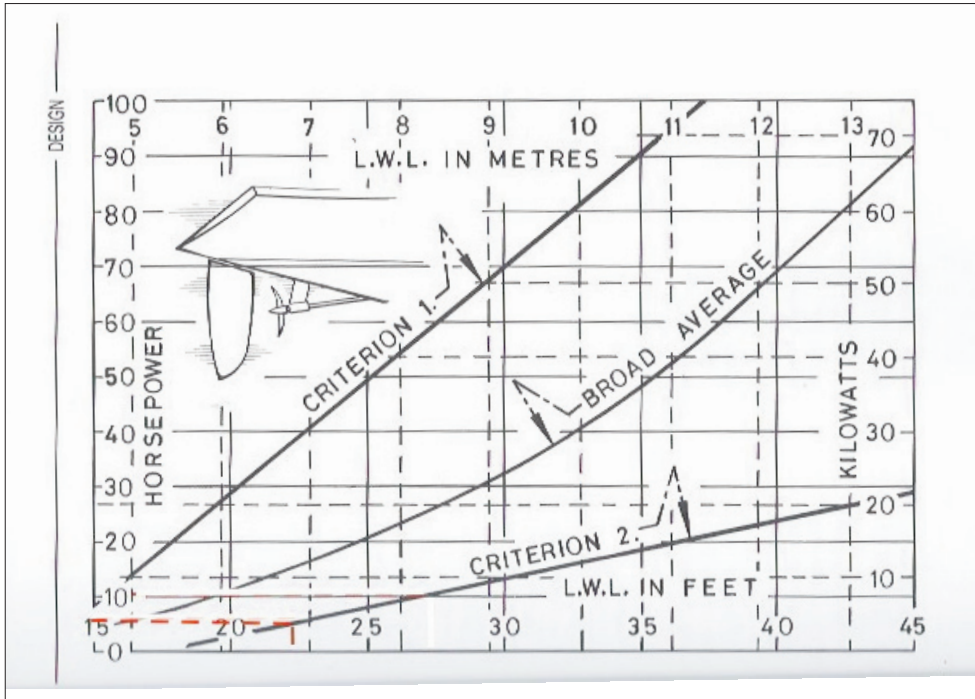

© Ian Nicolson, 2003, The Boat Data Book, Adlard Coles Nautical, an imprint of Bloomsbury Publishing Plc.

Appendix 7.9 Chart - Position of Sinking of Yacht Black Magic



Appendix 7.10 IRCG SITREP

ROUTINE
13 1213Z DEC 21
FROM MRSC VALENTIA
TO MRSC VALENTIA SITREP GROUP

BT
BOAT ON FIRE CROSSHAVEN
UJIN2883/21
SAR SITREP ONE AND FINAL

A - IDENTITY OF CASUALTY:
26FT YACHT

B - POSITION
51°46.70'N 008°18.02'W

C - SITUATION
MARSAR

D - NUMBER OF PERSONS
1

E - ASSISTANCE REQUIRED
LOCATE AND ASSIST

F - COORDINATING RCC
MRSC VALENTIA

G - DESCRIPTION OF CASUALTY
26FT YACHT

H - WEATHER ON SCENE
WIND: 1, E / SEA: MODERATE / SWELL: LOW WAVE / AIR TEMP: 8.1°C / WATER TEMP: 10°C / CLOUD COV: OVERCAST / SITREP WEATHER-TIME: 13 1152Z DEC 21

J - INITIAL ACTIONS TAKEN
TASKED CROSSHAVEN RNLI, R117, INFORM AGS

K - SEARCH AREA
CROSSHAVEN, RINGABELLA BOUY

L - COORDINATING INSTRUCTIONS
LOCATE AND ASSIST

M - FUTURE PLANS
NO FURTHER ACTION

N - ADDITIONAL INFORMATION
1152 MOP REPORTS YACHT ON FIRE CROSSHAVEN
(47 INCOMING 999 CALLS)
1153 TASKED XHAVEN RNLI
1154 TASKED R117
1154 " BOY CONNOR" B'CAST MAYDAY RELAY
1156 RNLI PROCEEDING
1158 " MAWRENA" CONFIRMS 1 POB TAKEN FROM BURNING YACHT
1201 "ANNABELLA" CONFIRMS 1 POB TAKEN FROM YACHT
1206 RIB " DELTA 1" HAS CASUALTY ONBOARD TO RCYC.
1217 CASUALTY ASHORE, ASSESSED BY RNLI MEDICAL - IN GOOD HEALTH
1248 XHAVEN RNLI CONFIRMS YACHT HAS SUNK (51 46.35 N 008 16.8 W)/ NO DEBRIS OR POLLUTION.
1300 XHAVEN LB RTB

Regards,



Appendix 7.11 Met Éireann Weather Report



Met Éireann

The Irish Meteorological Service

Climate Services
Glasnevin Hill
Dublin 9

Seirbhísí Aeráide
Cnoc Ghlas Naíon
Baile Átha Cliath 9

Tel: +353-1-8064260
Email: enq@met.ie
Email: legal@met.ie

Our Ref: WS1730/2204_19

Your Ref: MCIB/12/313

Estimated weather conditions for Cork Harbour / Roches Point area on the morning of Monday 13th December 2021 between 09:00 and 13:00 hours UTC.

<u>Meteorological Synopsis:</u>	A light northeasterly or variable airflow covered the southern half of Ireland on 13-December-2021 due to a low pressure system (1008 hPa) to the south of the country which was near-stationary; an associated weather front (warm front) slowly tracked northwards reached southern coastal waters by forenoon.
<u>Wind:</u>	Winds were light to moderate Beaufort Force 3 or 4 (mean wind speed 6 to 10 knots) with occasional gusts of up to 16 knots. Wind direction was east-northeasterly during the period in question.
<u>Visibility:</u>	Visibility was mostly good (greater than 5 nautical miles) but moderate in precipitation (2 to 4 nm).
<u>Weather:</u>	It was overcast and dry for most of the period. Outbreaks of drizzle or light rain moved in from the south towards the end of the period.
<u>Temperature:</u>	Air temperature of 6 or 7 degrees Celsius.

Estimated Sea State Conditions (offshore): the estimated sea state conditions in the offshore area south of Roches Point was moderate to rough with significant total wave height of 2.5 to 3.0 meters and maximum wave height of 4.5 meters. Swell direction was southwesterly.

Sea temperature: 11 degrees Celsius.

This report was issued on: 13 April 2022

Met Éireann | Climate Services | Legal Unit | Email: legal@met.ie

Appendix 7.11 Met Éireann Weather Report



Met Éireann

The Irish Meteorological Service

Climate Services

Glasnevin Hill

Dublin 9

Seirbhísí Aeráide

Cnoc Ghlas Naíon

Baile Átha Cliath 9

Tel: +353-1-8064260

Email: enq@met.ie

Email: legal@met.ie

Appendix 1a Wind Rose and Data Graph from Meteorological Station Roches Point

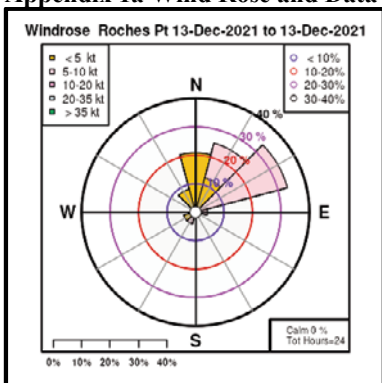

WEATHER STATION REPORTS FROM ROCHES POINT

Date	Rainfall (mm)	Max Temp (°C)	Min Temp (°C)	Grass Min Temp (°C)	Mean Wind Speed (knots)	Max Gust (>= 34 knots)
13/12/2021	1.3	8.4	6.8	4.0	5.4	

HOURLY VALUES (UTC) 13 Dec 2021 ROCHES POINT

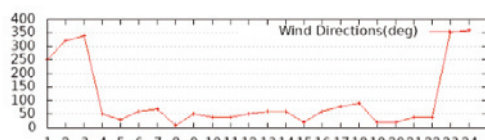
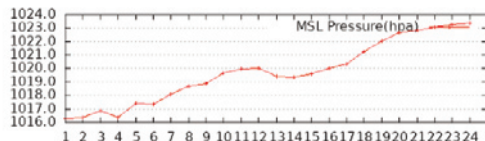
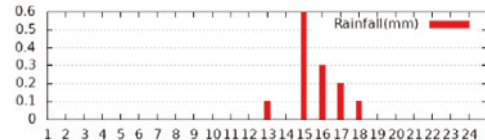
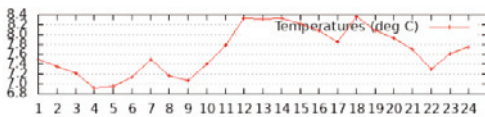

Appendix 7.11 Met Éireann Weather Report



Met Éireann

The Irish Meteorological Service

Climate Services
Glasnevin Hill
Dublin 9

Seirbhísí Aeráide
Cnoc Ghlas Naíon
Baile Átha Cliath 9

Tel: +353-1-8064260
Email: enq@met.ie
Email: legal@met.ie

Appendix 1b Wind Rose and Data Table from Buoy M5 (station number stno=62094) located south of Hook Head

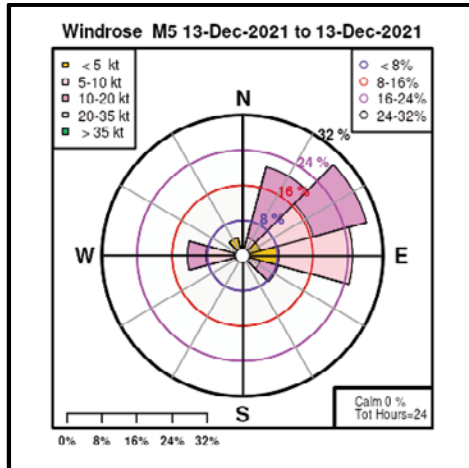

stno	date_time	wind_dir	mean_wind_speed_knots	max_wind_gust_knots	sig_wave_height	max_wave_height	wav_dir	sig_wave_period
62094	13-Dec-2021 00:00:00	256.3	12.1	19.0	3.7	5.2	232.0	7.1
62094	13-Dec-2021 01:00:00	259.8	8.2	13.8	3.9	5.5	233.4	7.3
62094	13-Dec-2021 02:00:00	283.7	5.9	11.4	3.6	5.9	230.6	7.3
62094	13-Dec-2021 03:00:00	327.3	4.8	9.7	3.3	5.0	230.6	6.9
62094	13-Dec-2021 04:00:00	52.7	2.7	6.6	3.1	4.3	222.2	6.9
62094	13-Dec-2021 05:00:00	88.6	4.6	9.3	3.4	4.2	226.4	7.5
62094	13-Dec-2021 06:00:00	108.6	6.4	11.0	3.0	4.3	220.8	7.5
62094	13-Dec-2021 07:00:00	103.7	4.7	9.3	3.0	4.5	225.0	7.6
62094	13-Dec-2021 08:00:00	104.4	5.7	9.6	2.6	4.0	223.6	7.4
62094	13-Dec-2021 09:00:00	100.9	6.7	10.4	2.8	4.2	219.4	7.6
62094	13-Dec-2021 10:00:00	95.6	8.8	14.5	2.8	4.5	223.6	7.7
62094	13-Dec-2021 11:00:00	106.2	10.3	14.8	2.6	3.4	220.8	7.4
62094	13-Dec-2021 12:00:00	89.3	8.7	13.6	2.7	4.1	219.4	7.3
62094	13-Dec-2021 13:00:00	58.7	9.2	15.7	2.6	3.8	225.0	7.3
62094	13-Dec-2021 14:00:00	42.5	9.5	14.6	2.7	3.8	219.4	7.3
62094	13-Dec-2021 15:00:00	29.5	12.6	17.9	2.4	3.5	219.4	6.8
62094	13-Dec-2021 16:00:00	23.6	13.3	18.3	2.6	3.9	229.2	7.1
62094	13-Dec-2021 17:00:00	18.6	13.4	19.7	2.5	4.0	229.2	7.0
62094	13-Dec-2021 18:00:00	47.8	13.0	19.8	2.2	3.5	222.2	6.2
62094	13-Dec-2021 19:00:00	39.7	11.6	18.2	2.2	3.2	219.4	6.3
62094	13-Dec-2021 20:00:00	53.1	11.7	17.2	2.0	2.6	219.4	6.3
62094	13-Dec-2021 21:00:00	57.0	11.2	16.3	2.1	2.8	222.2	6.3
62094	13-Dec-2021 22:00:00	54.5	9.8	15.7	2.0	3.0	219.4	6.3
62094	13-Dec-2021 23:00:00	56.6	9.5	14.4	1.9	2.6	212.3	6.1

Appendix 7.11 Met Éireann Weather Report



Met Éireann

The Irish Meteorological Service

Climate Services
Glasnevin Hill
Dublin 9

Seirbhís Aeráide
Cnoc Ghlas Naíon
Baile Átha Cliath 9

Tel: +353-1-8064260
Email: enq@met.ie
Email: legal@met.ie

Appendix 1c Analysis Chart 12UTC 13-December-2021

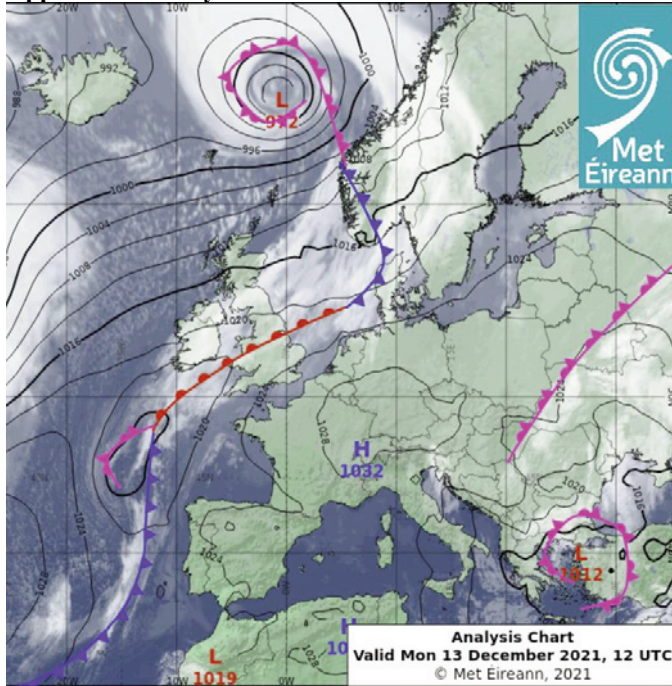

Appendix 1d Hourly Radar Images

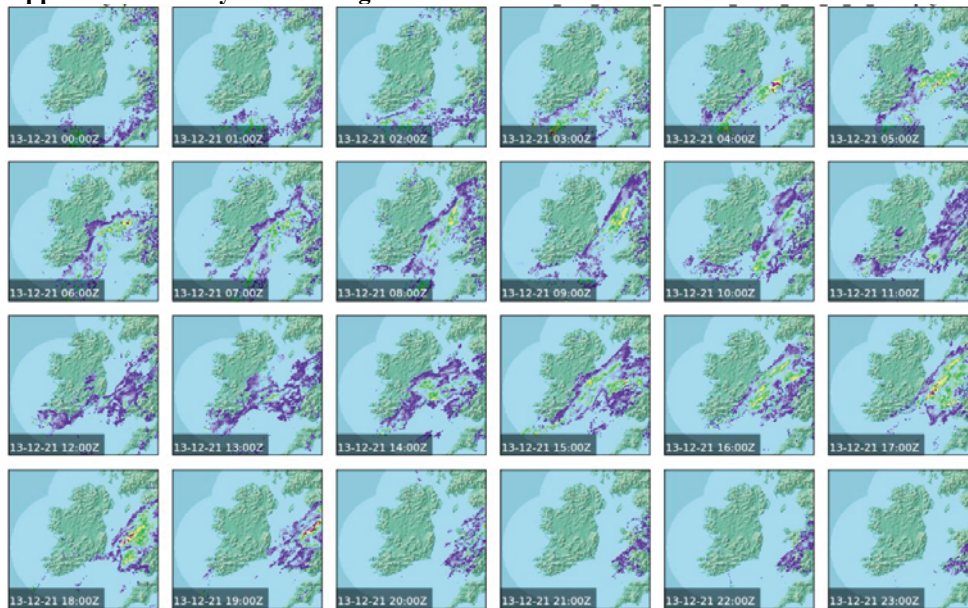

Met Éireann | Climate Services | Legal Unit | Email: legal@met.ie

Appendix 7.11 Met Éireann Weather Report



Text of Gale Warning

Nil

Text of Small Craft Warning

1. Westerly winds will reach force 6 or 7 at times on Sunday night and on Monday morning on Irish coasts from Erris Head to Rossan Point to Fair Head.
2. Southwest winds will reach force 6 or 7 at times on Monday night on Irish coasts from Loop Head to Erris Head to Malin Head.

Coastal Reports

Malin Head Automatic	West, 31 Knots, Gust 54 Knots, Mod drizzle, 2 Miles, 1005, Rising very rapidly
Dublin Airport	West-Southwest, 14 Knots, Gust 30 Knots, Cloudy, 10 Miles, 1011, Rising rapidly
Buoy M15 51° 41'N 6° 42'W	West, 14 Knots, Wave ht: 3.8 m. The visibility at Tuskar is 8 Miles, 1015, Rainy
Roches Point Automatic	West-Southwest, 8 Knots, Fair, 6 Miles, 1015, Rising rapidly
Sherkin Island Automatic	West, 4 Knots, Mist, 2 Miles, 1015, Rising
Valentia Automatic	South, 2 Knots, Fair, 11 Miles, 1014, Rising
Mace Head Automatic	West, 21 Knots, Cloudy, 5 Miles, 1012, Rising rapidly
Belmullet Automatic	West, 15 Knots, Gust 27 Knots, Fair, 8 Miles, 1010, Rising very rapidly
Buoy M1 53° 8'N, 11° 12'W	Report not available
Buoy M2 53° 29'N, 6° 26'W	Southwest, 21 Knots, Wave ht: 3.1 m, 1011, Rising
Buoy M3 51° 13'N, 10° 33'W	West-Northwest, 8 Knots, Wave ht: 6.1 m, 1014, Rising slowly
Buoy M4 55° 0'N 10° 0'W	West, 27 Knots, Gust 38 Knots, Wave ht: 6.5 m, 1006, Rising very rapidly
Buoy M6 53° 4'N 15° 56'W	West, 22 Knots, Wave ht: 5.2 m, 1011, Rising

Disclaimer: buoy locations are approximate and are not for navigational purposes

Sea Crossings

Dublin - Holyhead	State of sea until 0000 Wednesday 15 December 2021 Moderate, decreasing slight on Monday afternoon. Increasing moderate on Tuesday afternoon.
Rosslare - South Wales	Moderate, decreasing slight on Monday afternoon. Increasing moderate on Tuesday afternoon.
Cork - South Wales	Rough to very rough, decreasing moderate to rough on Monday evening.
Rosslare - France	Rough to very rough. Decreasing moderate to rough on Monday evening.
Cork - France	Rough to very rough. Decreasing moderate to rough on Monday evening.

Next update before 0700 Monday, 13 December 2021



24-hour Sea Area Forecast

Updated at 0000 / 0600 / 1200 / 1800

Sea Area Forecast until 0000 Tuesday, 14 December 2021
Issued at 0000 Monday, 13 December 2021

1. **Gale warning:** Nil
Small craft warning: In operation
2. **Meteorological situation at 2100:** A depression of 988hPa centred west of Scotland tracks northwards generating a strong southerly airflow over the country, which will veer westerly and ease through Monday.
3. **Forecast for Irish coastal waters from Loop Head to Bloody Foreland to Belfast Lough**
Wind: West force 5 or 6, occasionally force 7 in northern sea areas. Soon decreasing southwest force 4 or 5. Later increasing force 6 or 7, but remaining force 5 or 6 in the North Channel.
Weather: Cloudy to fair with scattered showers.
Visibility: Mostly good.
4. **Forecast for Irish coastal waters from Belfast Lough to Camsore Point to Loop Head and the Irish Sea**
Wind: West to northwest force 3 or 4 imminent. Soon veering north to northeast force 3 or 4. Backing west force 3 or 4 by the end of the period.
Weather: Cloudy in the southeast with outbreaks of rain, cloudy to fair elsewhere.
Visibility: Cloudy to poor in any precipitation.
Warning of Heavy Swell: on Atlantic coasts
5. **Outlook for a further 24 hours until 0000 Wednesday 15 December 2021:** Fresh to strong southwesterly winds in western, northern and northeastern sea areas with gales developing in the northwest on Monday night and Tuesday. Moderate to fresh southwesterlies elsewhere. Weather: Rain and drizzle in the northwest at times otherwise cloudy to fair.

Appendix 7.11 Met Éireann Weather Report



24-hour Sea Area Forecast

Updated at 0000 / 0600 / 1200 / 1800

Sea Area Forecast until 0600 Tuesday, 14 December 2021
Issued at 0600 Monday, 13 December 2021

1. Gale warning: In operation
 Small craft warning: In operation
2. Meteorological situation at 0300: A depression of 979hPa centred north of Scotland generates a fresh to strong westerly airflow over the north of the country, whilst a depression of 1008hPa centred west of France generates a light variable airflow over the south of the country.
3. Forecast for Irish coastal waters from Loop Head to Bloody Foreland to Belfast Lough
Wind: West to southwest force 4 or 5, occasionally force 6 in northern sea areas. Soon backing southwest force 4 or 5. Later increasing force 6 or 7, reaching gale force 8 between Erris Head and Malin Head by the end of the period.
Weather: Cloudy to fair with scattered showers. Becoming cloudy later with patchy drizzle along northern coasts.
Visibility: Mostly good. Moderate to poor in precipitation.

Forecast for Irish coastal waters from Belfast Lough to Carrlingford Lough to Wicklow Head and for the north Irish Sea
Wind: West to northwest force 2 to 4. Backing southwest force 4 or 5 by the end of the period.
Weather: Cloudy to fair.
Visibility: Mostly good.

Forecast for Irish coastal waters from Wicklow Head to Roche's Point to Loop Head and for the south Irish Sea
Wind: Variable force 3 or less. Soon becoming north to northeast force 3 or 4. Later backing west force 2 or 3, increasing force 4 or 5 by the end of the period.
Weather: Cloudy with outbreaks of rain and drizzle.
Visibility: Moderate to poor in any precipitation.

Warning of Heavy Swell: on Atlantic coasts

4. Outlook for a further 24 hours until 0600 Wednesday 15 December 2021: Fresh to strong southwesterly winds in western, northern and northeastern sea areas with gales developing in the northwest on Tuesday morning. Moderate to fresh southwesterlies elsewhere. Weather: Rain and drizzle in the northwest at times otherwise cloudy to fair.



Text of Gale Warning

Southwest winds will reach gale force 8 on Tuesday morning on Irish coastal waters from Erris Head to Rossan Point to Malin Head.

Text of Small Craft Warning

1. Westerly winds will reach force 6 or 7 at times on Monday morning on Irish coasts from Erris Head to Rossan Point to Fair Head. 2. Southwest winds will reach force 6 or 7 at times on Monday night on Irish coasts from Valentia to Slyne Head to Erris Head and from Malin Head to Belfast Lough to Carrlingford Lough.

Coastal Reports	
Main Head Automatic	5 AM Monday, 13 December 2021
Dublin Airport	Southwest, 17 Knots. Recent rain. 12 Miles. 1013. Rising
Buoy M6 51° 41'N 6° 42'W	Southwest, 4 Knots. Fair. 10 Miles. 1017. Rising slowly
Roches Point Automatic	East, 5 Knots. Wave ht: 3.4 m. The visibility at Tuskar is 7 Miles. 1017. Rising slowly
Sherkin Island Automatic	North-Northeast, 5 Knots. Cloudy. 18 Miles. 1017. Rising slowly
Valentia Automatic	Northeast, 4 Knots. Mist. 4 Miles. 1017. Rising slowly
Malin Head Automatic	East-Northeast, 5 Knots. Fair. 11 Miles. 1017. Rising slowly
Belmullet Automatic	Southwest, 13 Knots. Fair. 9 Miles. 1016. Rising slowly
Buoy M1 53° 8'N, 11° 12'W	West, 13 Knots. Gust 26 Knots. Rain shower. 6 Miles. 1015. Rising
Buoy M2 53° 29'N, 6° 26'W	Report not available
Buoy M3 51° 13'N, 10° 33'W	West, 11 Knots. Wave ht: 1.7 m. 1017. Rising slowly
Buoy M4 55° 0'N 10° 0'W	Northeast, 6 Knots. Wave ht: 6 m. 1016. Rising slowly
Buoy M6 53° 4'N 15° 56'W	West-Southwest, 21 Knots. Gust 31 Knots. Wave ht: 5.2 m. 1012. Rising
	West, 19 Knots. Wave ht: 4.4 m. 1014. Rising slowly

Disclaimer: buoy locations are approximate and are not for navigational purposes

Sea Crossings	
Dublin - Holyhead	State of sea until 0600 Wednesday 15 December 2021
Rosslare - South Wales	Moderate, decreasing slight on Monday afternoon. Increasing moderate on Tuesday afternoon.
Cork - South Wales	Moderate, decreasing slight on Monday afternoon. Increasing moderate on Tuesday afternoon.
Rosslare - France	Rough to very rough. Decreasing moderate to rough on Monday evening
Cork - France	Rough to very rough. Decreasing moderate to rough on Monday evening

Next update before 1300 Monday, 13 December 2021

Appendix 7.11 Met Éireann Weather Report



24-hour Sea Area Forecast

Updated at 0000 / 0600 / 1200 / 1800

Sea Area Forecast until 1200 Tuesday, 14 December 2021
Issued at 1200 Monday, 13 December 2021

1. **Gale warning:** In operation
Small craft warning: In operation
2. **Meteorological situation at 0900:** A depression of 972hPa centred near Shelland continues to clear north leaving Ireland in a moderate southwest or variable air-flow. A strengthening southwest air-flow will develop later.
3. **Forecast for Irish coastal waters from Wicklow Head to Dungarvan to Mizen Head**
Wind: Northeast force 3 or 4, reaching force 5 off the southeast coast. Becoming variable force 3 or less later. Becoming southwest force 4 or 5 Tuesday morning.
Weather: Scattered outbreaks of rain, drizzle and mist, clearing later. Inland fog tonight.
Visibility: Generally moderate or poor.

Forecast for Irish coastal waters from Mizen Head to Malin Head to Wicklow Head and for the Irish Sea
Wind: West or southwest force 3 or 4, increasing to force 5 off the north coast. Soon becoming southwest force 4 or 5. Later becoming southwest force 5 to 7 and reaching gale force 8 between Erris Head and Malin Head.
Weather: Generally fair or cloudy weather with isolated showers. Patchy rain or drizzle developing later.
Visibility: Often good today. Moderate or poor in precipitation.

Warning of Heavy Swell: Nil

4. **Outlook for a further 24 hours until 1200 Wednesday 15 December 2021:** Strong southwest winds on western and northern coasts, moderate to fresh southwest winds on eastern and southern coasts. Occasional light rain or drizzle.



Text of Gale Warning

Southwest winds will reach gale force 8 later tonight and on Tuesday on Irish coastal waters from Malin Head to Belfast Lough to Carrlingford Lough and from Mizen Head to Loop Head to Erris Head.

Text of Small Craft Warning

Southwest winds will reach force 6 or higher later tonight and Tuesday, on Irish coasts from Malin Head to Belfast Lough to Carrlingford Lough and from Mizen Head to Loop Head to Erris Head.

Coastal Reports

Malin Head Automatic	Southwest, 17 Knots, Gust 30 Knots, Rain shower, 9 Miles, 1017, Raising slowly
Dublin Airport	South, 2 Knots, Cloudy, 21 Miles, 1020, Raising slowly
Buoy M6 51° 41'N 6° 42'W	East-Southeast, 10 Knots, Wave ht: 2.6 m, The visibility at Tuskar is greater than 10 Miles, 1019, Raising slowly
Roches Point Automatic	Northeast, 6 Knots, Cloudy, 21 Miles, 1020, Raising slowly
Sherkin Island Automatic	Northeast, 7 Knots, Cloudy, 9 Miles, 1020, Raising slowly
Valentia Automatic	North, 1 Knot, Cloudy, 16 Miles, 1020, Raising slowly
Mace Head Automatic	West, 6 Knots, Fair, 5 Miles, 1019, Raising slowly
Balmullet Automatic	Southwest, 9 Knots, Fair, 8 Miles, 1018, Raising slowly
Buoy M1 53° 8'N, 11° 12'W	Report not available
Buoy M2 53° 29'N, 6° 26'W	West-Southwest, 5 Knots, Wave ht: 0.8 m, 1020, Raising slowly
Buoy M3 51° 13'N, 10° 33'W	East-Northeast, 11 Knots, Wave ht: 4.6 m, 1019, Raising slowly
Buoy M4 55° 01'N 10° 01'W	West-Southwest, 23 Knots, Wave ht: 4.7 m, 1017, Raising slowly
Buoy M6 53° 41'N 16° 56'W	Southwest, 17 Knots, Wave ht: 4.5 m, 1018, Raising slowly

Disclaimer: buoy locations are approximate and are not for navigational purposes

Sea Crossings

Dublin - Holyhead	State of sea until 1200 Wednesday 15 December 2021
Rosslare - South Wales	Moderate
Cork - South Wales	Moderate
Rosslare - France	Rough or very rough today. Becoming moderate Tuesday and on Wednesday
Cork - France	Rough or very rough today. Becoming moderate Tuesday and on Wednesday

Next update before 1900 Monday, 13 December 2021

Appendix 7.11 Met Éireann Weather Report



24-hour Sea Area Forecast

Updated at 0000 / 0600 / 1200 / 1800

Sea Area Forecast until 1800 Tuesday, 14 December 2021
 Issued at 1800 Monday, 13 December 2021

- Gale warning:** In operation
Small craft warning: In operation
- Meteorological situation at 1500:** A light to moderate southwest or variable air-flow covers Ireland. A strengthening southwest air-flow will develop Tuesday with low pressure of 968hPa centred southwest of Iceland.

3. Forecast for Irish coastal waters from Wicklow Head to Dungarvan to Mizen Head

Wind: North or variable force 2 to 4. Becoming southwest force 4 or 5 Tuesday later.
Weather: Scattered outbreaks of rain, drizzle and mist clearing. Inland fog drifting offshore at times.
Visibility: Poor near fog, otherwise mostly good.

Forecast for Irish coastal waters from Malin Head to Wicklow Head and for the Irish Sea

Wind: Southwest force 3 or 4, increasing to force 5 off the north coast. Soon becoming southwest force 4 or 5. Later becoming southwest force 5 to 7 and reaching gale force 8 between Erris Head and Malin Head.
Weather: Generally fair or cloudy weather with isolated showers. Inland fog drifting offshore at times.
Visibility: Poor near fog, otherwise mostly good.

Warning of Heavy Swell: Nil

- Outlook for a further 24 hours until 1800 Wednesday, 15-Dec-2021:** Strong southwest winds on western and northern coasts, moderate to fresh southwest winds on eastern and southern coasts. Occasional light rain or drizzle.



Text of Gale Warning
 Southwest winds will reach gale force 8 later tonight and on Tuesday on Irish coastal waters from Erris Head to Rossare Point to Malin Head.

Text of Small Craft Warning
 Southwest winds will reach force 6 or higher later tonight and Tuesday, on Irish coasts from Malin Head to Belfast Lough to Carrlingford Lough and from Mizen Head to Loop Head to Erris Head.

Coastal Reports	3 PM Monday, 13 December 2021
Malin Head Automatic	South-Southwest, 14 Knots, Fair, 5 Miles, 1018, Rising slowly
Dublin Airport	Southwest, 2 Knots, Cloudy, 10 Miles, 1020, Steady
Buoy M6 61° 41'N 6° 42'W	North-Northeast, 13 Knots, Wave ht. 2.4 m, The visibility at Tuskar is 3 Miles, 1018, Falling slowly
Roches Point Automatic	North-East, 4 Knots, Light rain, 5 Miles, 1019, Steady
Sherkin Island Automatic	North-Northeast, 7 Knots, Recent drizzle, 15 Miles, 1019, Steady
Valentia Automatic	West-Northwest, 2 Knots, Fair, 9 Miles, 1019, Steady
Maca Head Automatic	Southwest, 6 Knots, Fair, 9 Miles, 1019, Steady
Binnulliet Automatic	West-Southwest, 7 Knots, Fair, 11 Miles, 1019, Steady
Buoy M1 53° 8'N, 11° 12'W	Report not available
Buoy M2 53° 29'N, 5° 26'W	Northwest, 7 Knots, Wave ht. 0.6 m, 1020, Steady
Buoy M3 61° 13'N, 10° 33'W	Northwest, 10 Knots, Wave ht. 4 m, 1019, Steady
Buoy M4 65° 07'N 10° 0'W	West-Southwest, 17 Knots, Wave ht. 4.4 m, 1017, Steady
Buoy M6 53° 47'N 5° 56'W	Southwest, 20 Knots, Wave ht. 4.5 m, 1017, Steady

Disclaimer: buoy locations are approximate and are not for navigational purposes

Sea Crossings	State of sea until 1800 Wednesday, 15-Dec-2021
Dublin - Holyhead	Moderate
Rosslare - South Wales	Moderate
Cork - South Wales	Moderate
Rosslare - France	Rough or very rough today, Becoming moderate Tuesday and on Wednesday
Cork - France	Rough or very rough today, Becoming moderate Tuesday and on Wednesday

Next update before 0100 Tuesday, 14 December 2021

Appendix 7.11 Met Éireann Weather Report



Met Éireann
The Irish Meteorological Service

Climate Services
Glasnevin Hill
Dublin 9

Seirbhísí Aeráide
Cnoc Ghlas Naíon
Baile Átha Cliath 9

Tel: +353-1-8064260
Email: legal@met.ie

Appendix 3a Terminology Sea Area Map & Beaufort Scale of Wind

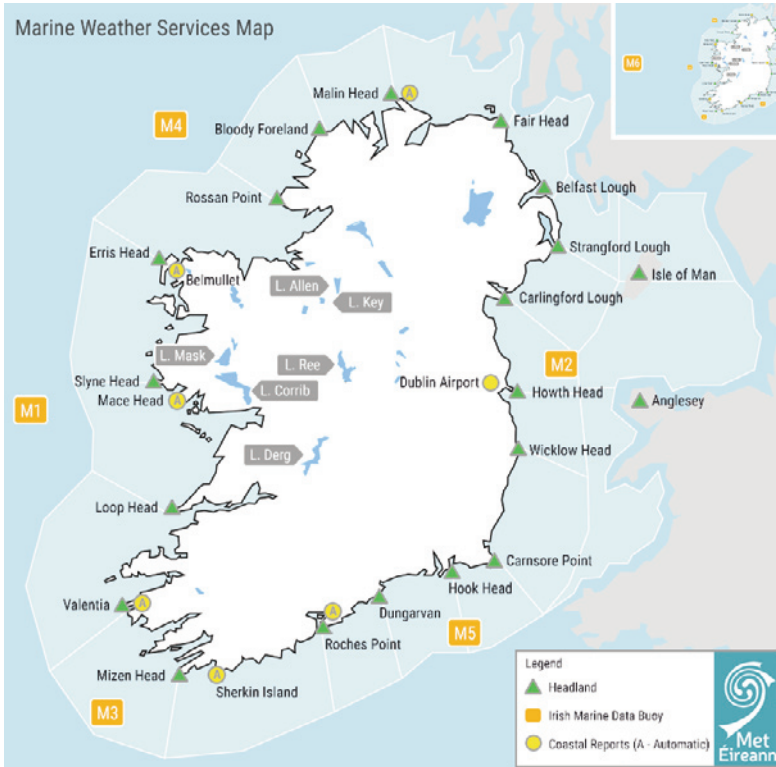

Beaufort Scale of Wind					
Force	Description	Speed*		Specification -sea	Wave height** (metres)
		knots	km/hr		
0	Calm	<1	<1	Sea like mirror	
1	Light air	1-3	1-5	Ripples	0.1 (0.1)
2	Light breeze	4-6	6-11	Small wavelets	0.2 (0.3)
3	Gentle breeze	7-10	12-19	Large wavelets, crests begin to break	0.6 (1)
4	Moderate breeze	11-16	20-28	Small waves becoming longer, frequent white horses	1 (1.5)
5	Fresh breeze	17-21	29-38	Moderate waves, many white horses, chance of spray	2 (2.5)
6	Strong breeze	22-27	39-49	Large waves, white foam crests, probably some spray	3 (4)
7	Near gale	28-33	50-61	Sea heaps up, streaks of white foam	4 (5.5)
8	Gale	34-40	62-74	Moderately high waves of greater length	5.5 (7.5)
9	Strong gale	41-47	75-88	High waves, dense streaks of foam, spray may reduce visibility	7 (10)
10	Storm	48-55	89-102	Very high waves, long overhanging crests, visibility affected	9 (12.5)
11	Violent storm	56-63	103-117	Exceptionally high waves, long white foam patches cover sea	11.5 (16)
12	Hurricane	64+	117 & over	Air filled with foam and spray, sea completely white	14 (-)

*Speed = mean speed at a standard height of 10 metres.
**Wave height is only intended as a guide to what may be expected in the open sea. Bracketed figures indicate the probable maximum wave height.

Appendix 7.11 Met Éireann Weather Report



Met Éireann

The Irish Meteorological Service

Climate Services
Glasnevin Hill
Dublin 9

Seirbhísí Aeráide
Cnoc Ghlas Naíon
Baile Átha Cliath 9

Tel: +353-1-8064260
Email: enq@met.ie
Email: legal@met.ie

Appendix 3b Terminology Sea State & Visibility

Wave Heights / State of Sea:

The wave height is the vertical distance between the crest and the preceding or following trough. The table below gives a description of the wave system associated with a range of significant wave heights.

The Significant wave height is defined as the average height of the highest one-third of the waves. (It is very close to the value of wave height given when making visual observations of wave height.)

Sea State (Descriptive)	Significant Wave height in meters
Calm	0 – 0.1
Smooth(Wavelets)	0.1 – 0.5
Slight	0.5 – 1.25
Moderate	1.25 – 2.5
Rough	2.5 – 4
Very rough	4 – 6
High	6 – 9
Very high	9 – 14
Phenomenal	Over 14

Individual waves in the wave train will have heights in excess of the significant height. **The highest wave of all will have a height about twice the significant height.**

Visibility Descriptions:

Visibility (Descriptive)	Visibility in nautical miles (kilometres)
Good	More than 5 nm (> 9 km)
Moderate	2 – 5 nm (4 – 9 km)
Poor	0.5 – 2 nm (1 – 4 km)
Fog	Less than 0.5 nm (< 1km)

Please Note:

If there are no measurements or observations available for an exact location, then the estimated conditions in this report are based on all available meteorological measurements and observations which have been correlated on the routine charts prepared by Met Éireann.

Appendix 7.12 Tide and Light Conditions 13 December 2021
(Information courtesy of www.tidetimes.co.uk)

Roberts Cove tide times are listed below, including sunrise and sunset times, moon rise and moonset times, and the current moon phase. Simply use the tide calendar to view tide times up to 6 days in advance.

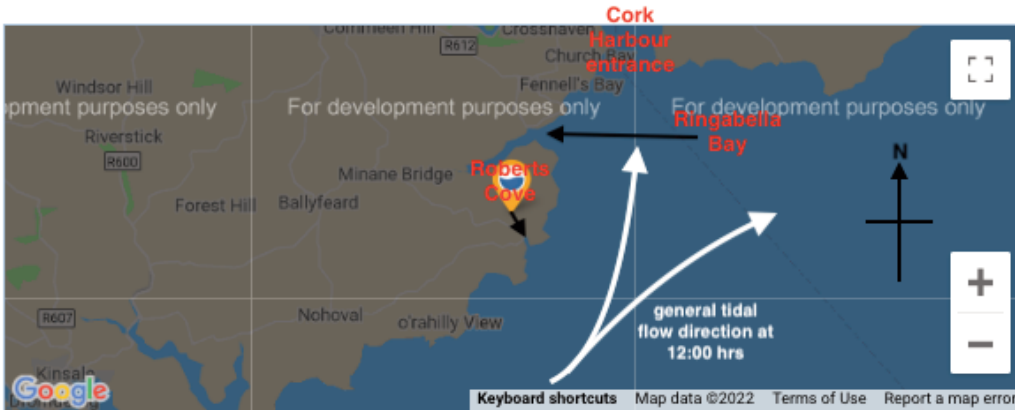

Monday 13th December, 2021

December 2021						
S	M	T	W	T	F	S
			1	2	3	4
5	6	7	8	9	10	11
12	13	14	15	16	17	18
19	20	21	22	23	24	25
26	27	28	29	30	31	

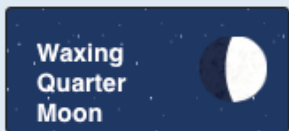

SUNRISE: 08:32

SUNSET: 16:23

MOONRISE: 14:01

MOONSET: 02:16

Tide Times UTC:

Hi/Lo	Time	Height
High	00:28	3.31m
Low	07:14	1.14m
High	13:05	3.47m
Low	19:44	1.20m

SECTION 36 PROCESS

Section 36 of the Merchant Shipping (Investigation of Marine Casualties) Act, 2000

It is a requirement under Section 36 that:

- (1) Before publishing a report, the Board shall send a draft of the report or sections of the draft report to any person who, in its opinion, is likely to be adversely affected by the publishing of the report or sections or, if that person be deceased, then such person as appears to the Board best to represent that person's interest.
- (2) A person to whom the Board sends a draft in accordance with subsection (1) may, within a period of 28 days commencing on the date on which the draft is sent to the person, or such further period not exceeding 28 days, as the Board in its absolute discretion thinks fit, submit to the Board in writing his or her observations on the draft.
- (3) A person to whom a draft has been sent in accordance with subsection (1) may apply to the Board for an extension, in accordance with subsection (2), of the period in which to submit his or her observations on the draft.
- (4) Observations submitted to the Board in accordance with subsection (2) shall be included in an appendix to the published report, unless the person submitting the observations requests in writing that the observations be not published.
- (5) Where observations are submitted to the Board in accordance with subsection (2), the Board may, at its discretion -
 - (a) alter the draft before publication or decide not to do so, or
 - (b) include in the published report such comments on the observations as it thinks fit.'

The Board reviews and considers all observations received whether published or not published in the final report. When the Board considers an observation requires amendments to the report, those amendments are made. When the Board is satisfied that the report has adequately addressed the issue in the observation, then no amendment is made to the report. The Board may also make comments on observations in the report.

Response(s) received following circulation of the draft report (excluding those where the Board has agreed to a request not to publish) are included in the following section.

The Board has noted the contents of all observations, and amendments have been made to the report where required.

8. MSA 2000 - SECTION 36 OBSERVATIONS RECEIVED

PAGE

8.1 Observation from Skipper and MCIB response

58

Note: The names and contact details of the individual respondents have been obscured for privacy reasons.

OBSERVATION 8.1

8.1 Observation from Skipper and MCIB response

From: [REDACTED]
Sent: Thursday 8 December 2022 15:24
To: [REDACTED]
Subject: Re: 313/MCIB - Black Magic fire and sinking

CAUTION: This eMail originated from outside your organisation and the BTS Managed Desktop service. Do not click on any links or open any attachments unless you recognise the sender or are expecting the email and know that the content is safe. If you are in any doubt, please contact the OGCIO IT Service Desk.

[REDACTED]

There are a few issues in the report. The Yacht is only 25.4 feet not 28 feet as in report many times making the small outboard sufficient to push her in the flat calm waters the day I travelled.

Here is what I sent to [REDACTED] recently on whats app below. He said to forward it to you to edit the document correctly.

[REDACTED] got the report today and just read it. All is ok but the yacht is only 25.42 feet NOT 28 feet and she had a waterline of 21.67 feet making her much easier to push through the water averaging 4 to 4.5 knots on my GPS. See Sailboat data picture attached. This was an extremely light yacht. I was hugging the coast as well to avoid the remaining tide which would have turned earlier at Cobh and hence would have been in my favour for 75% of the trip. It was flat calm and zero wind so little I raised the mainsail on the marina at Royal Cork Yacht Club hence not using my headsail. Hope you can edit these details on the report. If I had a fixed VHF there is no way I would have entered the cabin and having the handheld on a lanyard around my neck as I do always even racing saved me. Thank you for your help with all of this. Took me a long time to get over this and was having nightmares for a long time. Kind regards [REDACTED]

<https://sailboatdata.com/sailboat/first-class-8-beneteau>

Kind regards,
[REDACTED]

8.1 Observation from Skipper and MCIB response

General Details		
Design:	FIRST CLASS 8 1.71	
Type:	Bermudian Sloop	
Issue:	New Application	
Notes:	Standard hull data	
Notes:	Rig & saidata owner declared	

LH:	7.85	BO:	
LWP:	7.02	x:	
Hull Beam:	2.45	h:	
Boat Weight:	1400	SO:	
DLR:	152	y:	
Draft:	1.71		

Detail

- Iron fixed drop keel
- No wing keel
- Outboard motor: 15kg
- No propeller
- Internal ballast: 0 kg
- Weight includes batteries/cushions
- World Sailing OSR compliant lifelines fitted
- Manual power only for running rigging
- No variable/moveable ballast carried
- Most foot/forestay not adjusted while racing

Sailboat Specifications

both US metric

Keel Type:	Swing Keel
Rigging Type:	Fractional Sloop
LOA:	25.42 ft / 7.75 m
LWL:	21.67 ft / 6.61 m
Beam:	8.16 ft / 2.49 m

This site requires anonymous cookies and various third-party services to function properly. Please consent to allowing cookies and accept our Terms and Conditions. Accept

Hull Type:	Swing Keel
Rigging Type:	Fractional Sloop
LOA:	25.42 ft / 7.75 m
LWL:	21.67 ft / 6.61 m
Beam:	8.16 ft / 2.49 m
S.A. (reported):	316.00 ft ² / 29.36 m ²
Draft (max):	5.80 ft / 1.77 m
Draft (min):	2.25 ft / 0.69 m
Displacement:	3,100 lb / 1,406 kg
Ballast:	1,150 lb / 522 kg
S.A./Disp.:	23.84
Bal./Disp.:	37.10
Disp./Len.:	136.00
Construction:	FG
First Built:	1982
Last Built:	1994
# Built:	969
Builder:	Beneteau (FRA)
Designer:	Jeanneau/Isauro/Isauro

This site requires anonymous cookies and various third-party services to function properly. Please consent to allowing cookies and accept our Terms and Conditions. Accept

This site requires anonymous cookies and various third-party services to function properly. Please consent to allowing cookies and accept our Terms and Conditions. Accept

8.1 Observation from Skipper and MCIB response



MCIB RESPONSE:
The MCIB notes the contents of this observation.



Leeson Lane, Dublin 2.
Telephone: 01-678 3485/86.
email: info@mcib.ie
www.mcib.ie

